

Rylock™

WINDOWS & DOORS

**Enhancing
the way you live.**

Rylock offers an unequalled range of window and door systems designed to enable you to find the ideal solution for your next project.

Powered by

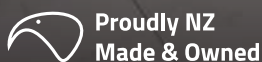

RYLOCK.CO.NZ | 0800 RYLOCK





Contents

- Introduction **3**
- How to Use This Brochure **5**
- Changes to the New Zealand Building Code **6**
- Window Formats **10**
- Door Formats **12**
- Rylock Windows Joinery Systems **14**
- Tasman35™ System **16**
- Pacific41™ System **20**
- Atlantic48™ System **24**
- Southern41™ Thermal System **28**
- Pacific52™ Thermal System **32**
- Baltic™ Commercial Systems **36**
- Other Systems **40**
- Retrofit, insert and replacement windows and doors **43**
- Stellar Doors™ **44**
- Digital Locks..... **46**
- Colour Options **47**
- Glass Selection **50**
- Hardware **52**
- Configurations **56**



**The perfect home
means different things
to different people.**

And often, the range of windows and doors available in one system simply isn't enough.

That's why, at **Rylock**, we offer you a choice of systems, each with its own distinctive style and benefits. So, talk to your local **Rylock** consultant and together we can create a home that inspires you.





Start and Develop a Plan

Before meeting your local Rylock consultant, it's a good idea to think about what you are trying to do and any preferences you may have. The following questions are a good place to start, and your consultant will be more than happy to help you answer them and any others you might have:

- Where will the sun hit your home during the day?
- How will your indoor and outdoor areas be linked?
- What do you like when it comes to window configurations?
- What would you like the thermal performance of your joinery to be?
- How do you want your joinery to integrate with the internal/exterior style of your home?
- Do you prefer sliding doors, stackers, hinged doors, bifold doors or Foldback™ bifold doors?

Your consultant will also help you work through any other factors you think important such as how you plan to use different areas around your home, your proximity to neighbours, how to optimise views, house orientation, and climate conditions like temperature and prevailing winds.

Ready to Create Your Dream Home?

It's an exciting prospect, yet there are so many considerations... where do you start?

- Do you want the best thermal insulation or the best weather protection?
- Would you like panoramic windows to make the most of the view?
- Or perhaps you want large doors that allow easy flow onto your deck for outdoor entertaining?
- Are you after an option that gives you the best value?

Whatever joinery selection you end up choosing one thing is for sure – it will be the culmination of multiple choices and preferences across a wide range of factors including personal taste, practicality and budget. At Rylock, we can help simplify this decision process for you because we provide a wide range of window and door systems, each with their own aesthetic and functional benefits.

Tasman35™ is designed to fit both traditional and modern architecture and can be integrated with our Pacific41™ system for a functional cost-effective look.

Pacific41™ enables your creativity to reign free. This architecturally designed system has a commercial style which suits modern architectural projects.

Atlantic48™ is designed for strength with edgy architectural lines and has the added capability of being able to cope with large span windows and doors.

Southern41™ Thermal is a thermally broken system designed to improve your home's insulation by extending the benefits of double glazing to the frames of your windows and doors.

Pacific52™ Thermal is next generation aluminium joinery with its unique thermal break providing improved insulation, noise reduction, strength and the virtual elimination of condensation.

How to Use This Brochure

On the following pages we've provided you with an overview of the benefits of:

1. Window Formats.....	10
2. Door Formats.....	12
3. Rylock Joinery systems	14
a. Tasman35™	16
b. Pacific41™	20
c. Atlantic48™	24
d. Southern41™ Thermal	28
e. Pacific52™ Thermal	32
4. Baltic™ Commercial Systems	36
5. Stellar Doors™	44

In order to help you identify the most appropriate system for your home we've itemised and explained a little about each of the window and door types you can choose from, e.g. Awning Windows, Casement Windows or Sliding Windows. We've also highlighted the benefits of each joinery system we offer in order to make it easy for you to compare. Plus, we've included an assortment of configurations, colours, handles and hardware to help you finalise your joinery selections.



Tips for choosing your joinery

The following tips will help you choose the most appropriate window and door types for specific areas in your home. Your local Rylock consultant will be happy to discuss your options in more detail.

- **Awning and Casement Windows** are better suited to areas where foot traffic is light, such as upstairs bedrooms
- **Sliding Windows** are a safe option for areas where children might play or where foot traffic is heavy, such as patios, side paths and balconies
- **Bifold Windows** offer greater open space so are perfect for use in your kitchen if a café feel is desirable however you may want to rethink this selection if the Bifold Windows are to project out onto decks or heavy foot traffic areas
- **Bifold Doors** are great for rooms that open out onto decks. You can include a hinged door for quick easy access, or a foldback option to increase deck space. Bifold Doors shouldn't be used in areas that are exposed to extreme wind conditions
- **Sliding and Stacker Doors** are great for decks and patios as they provide great access, reduced sight lines and extra light

Changes to the New Zealand Building Code¹

November 2022 sees a raft of changes introduced to section H1 of the New Zealand Building Code. H1 is the clause within the Code which sets out the energy efficiency performance levels that all new houses must meet, and many of the changes are related to windows and doors.

Here we highlight several areas that you need to be aware of when discussing your next building project with your window and door fabricator to ensure you achieve a compliant outcome.

¹ All building work in New Zealand must comply with the Building Code, a collection of rules and regulations designed to ensure that buildings are safe and fit for purpose. The code itself is split into more manageable chunks known as 'clauses'. Each clause sets out the performance standards for a specific aspect of a completed building. There are eight clauses, each identified by a letter, A through to H:

A - General provisions	E - Moisture
B - Stability	F - Safety of users
C - Protection from fire	G - Services and facilities
D - Access	H - Energy efficiency

The Ministry of Business, Innovation and Employment (MBIE) is responsible for maintaining the Code as well as ensuring the outcomes it delivers are beneficial to society.

R-value of your windows and doors

The R-value is a measure of how well a product is able to resist the transference of heat; in other words how well it insulates.

Therefore the larger the R-value, the greater the resistance and the greater the product's insulation properties. So, the higher the R-value of your windows and doors the better they'll be at keeping your house warm during the winter – that is, not letting the heat escape.

The R-value of your windows and doors is made up of two important factors:

- The R-value of the frame and
- The Ucgog value of the glass

Architects and engineers use these values to calculate the thermal efficiency of your windows and doors. H1 sets out the R-values that your windows and doors must meet in order to comply with New Zealand building standards.

Pairing different frame types (and their differing R-values) with different glass formats (and their differing Ucgog values) will enable you to achieve the values you require for your individual project.

The frame and its R-value

Window systems including the frames within them are responsible for 35%-50% of heat lost from your home, so any improvement you make to these systems will have a big impact on the overall thermal performance of your building. Choosing a thermally efficient frame, like the thermally broken frames found in our Southern41™ and Pacific52™ Systems or our uPVC Systems can enhance performance even more.

The glass and its Ucgog value

As you would imagine, glass plays an important role in the thermal performance of your windows. Low-emissivity (Low-E) glass has a transparent coating on the inside of the IGU (insulated glass unit) that reduces the amount of heat that can pass through the unit while still letting light through. Low-E coatings can be tailored to maximise or minimise the amount of energy from the sun that enters a building making them a popular choice for improving the thermal performance of home builds. Choosing to fill the double or triple glazing unit with an inert gas such as argon or krypton can further slow the flow of heat in and out of a house.

The amount of heat conducted or transferred through the glass unit is known as its Ucgog or U-value. A lower U-value indicates less conductivity therefore better insulation properties, so for better thermal efficiency you'll want to choose glass products that have a low U-value to bring down the overall U-value of your home.

Consult your architect or fabricator to learn more about these values in relation to specific products or your build.

Climate Zone

H1 splits New Zealand into six different climate zones. The table and map below are designed to help you identify which zone your project sits in. This is important because each zone has its own specific R-value requirements. And you need to know what value you are working to in order to achieve compliance.

Figure 1: Map of New Zealand climate zones

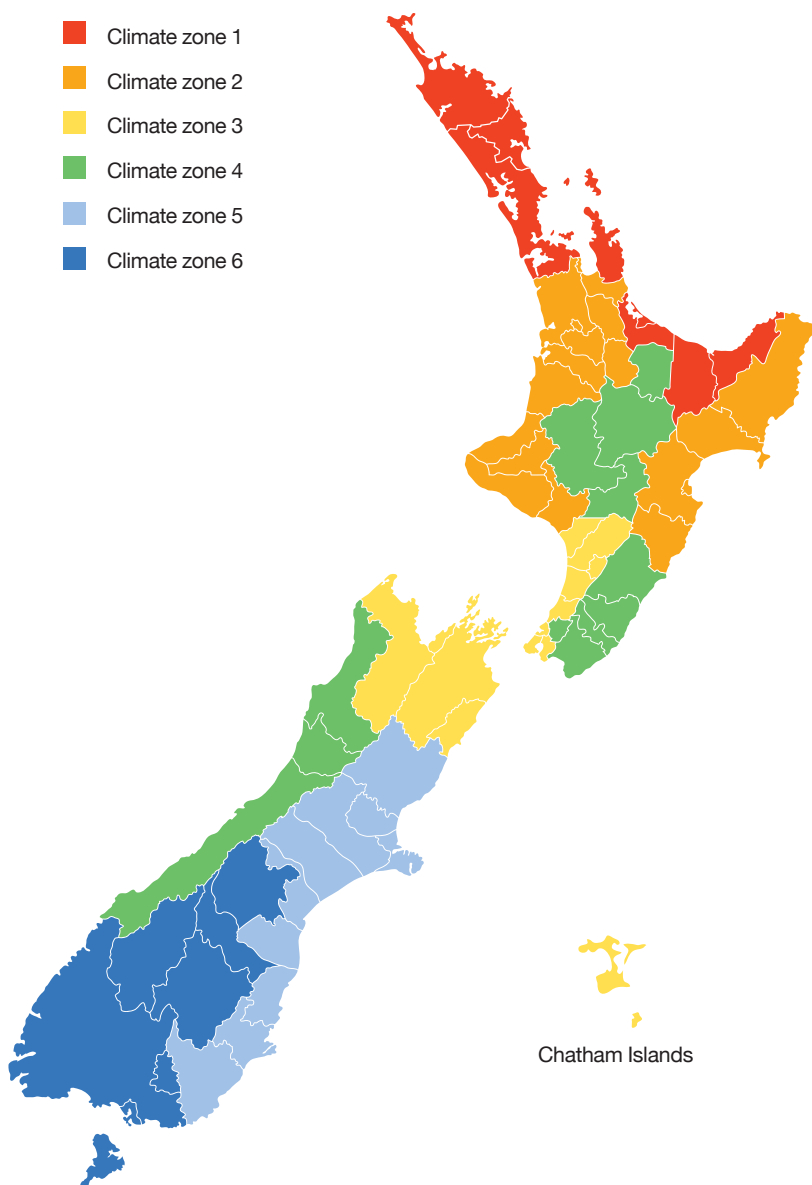

Territorial authority	Climate zone
North Island/Te Ika-a-Māui	
Far North District	1
Whangarei District	1
Kaipara District	1
Auckland	1
Thames-Coromandel district	1
Hauraki District	2
Waikato District	2
Matamata-Piako District	2
Hamilton City	2
Waipa District	2
Ōtorohanga District	2
South Waikato District	2
Waitomo District	2
Taupo District	4
Western Bay of Plenty District	1
Tauranga City	1
Rotorua District	4
Whakatane District	1
Kawerau District	1
Ōpōtiki District	1
Gisborne District	2
Wairoa District	2
Hastings District	2
Napier City	2
Central Hawke's Bay District	2
New Plymouth District	2
Stratford District	2
South Taranaki District	2
Ruapehu District	4
Whanganui District	2
Rangitikei District (north of 39°50'S (-39.83))	4
Rangitikei District (south of 39°50'S (-39.83))	3
Manawatu District	3
Palmerston North City	3
Tararua District	4
Horowhenua District	3
Porirua City	3
Upper Hutt City	4
Lower Hutt City	3
Wellington City	3
Masterton District	4
Carterton District	4
South Wairarapa District	4
South Island/Te Waipounamu	
Tasman District	3
Nelson City	3
Marlborough District	3
Kaikoura District	3
Buller District	4
Grey District	4
Westland District	4
Hurunui District	5
Waimakariri District	5
Christchurch City	5
Selwyn District	5
Ashburton District	5
Timaru District	5
Mackenzie District	6
Waimate District	5
Chatham Islands	3
Waitaki District (true left of the Otekaieke river)	6
Waitaki District (true right of the Otekaieke river)	5
Central Otago District	6
Queenstown-Lakes District	6
Dunedin City	5
Clutha District	5
Southland District	6
Gore District	6
Invercargill City	6

Table 1: Climate zones by territorial authority

The best frame and glass mix for **your project**

Once you have identified your climate zone requirements, the next step is to understand which frame and glass mix will work best for your project. There are three ways to demonstrate compliance:

a. Schedule Method

The Schedule Method is the simplest way to demonstrate compliance with the Building Code clause H1. It can only be used in cases where the glazing area of a building is 30% or less of the building's total wall area. The Schedule is literally a table that sets out the minimum R-values that can be obtained using various frame and IGU combinations. Locate the R-value relevant to your climate zone to identify which combination will ensure your compliance.

b. Calculation Method

The Calculation Method is typically used in cases where the glazing area of a building is 40% or less of the total wall area of the building in question.

c. Modelling Method - H1/VM1

The Modelling Method is used in cases where the glazing area is more than 40% of the building's total wall area. With this method there is no upper limit to the amount of glazing as a percentage of the total wall area.

Notes:

- (1) Thermal transmittance of the glazing determined using BS EN 673. Where the U_g -value of the proposed glazing is different from the values included in the table, R_{window} shall be determined based on the nearest U_g -value in the table that is greater than the U_g -value of the proposed glazing.
- (2) 'Thermally improved' refers to a spacer that meets the definition of thermally improved spacer in ISO 10077-1 Annex G.
- (3) The examples provided are informative descriptions only of the *insulated glazing unit (IGU)* types that might be used to deliver the nominated U_g -values. When using this table, R_{window} shall be determined based on U_g , spacer type and frame type.
- (4) The properties of each of the glass panes within the *IGU* are provided and separated by '/'. 'Clear' refers to clear float glass. 'Low E₁', 'Low E₂', 'Low E₃' and 'Low E₄' refer to glass with low emissivity coatings at different performance levels.

A General Guide

From November 2022 achieving the required R-value from the windows and doors on your project will depend on you and your fabricator selecting the most appropriate combination of spacers, frames, glass and gas. The table to the right is designed as a guide to help you find this best combination easily and quickly. It aligns our window and door systems with the R-value requirements of each climate zone and the timings involved in the changes.

Please note

- The timing of the application of the R-values is determined by the date a consent is lodged, not the date of construction
- These changes only apply to houses – residential buildings up to 300m² in size

	Former Systems	New go forward range
NTB (Non Thermally Broken Frame)	Pacific Residential, Smartfit, Sovereign Series, Weathertight	Tasman35™
	41Architectural, Pacific Architectural	Pacific41™
		Atlantic48™
TB (Thermally Broken Frame)	All Seasons	Southern41™ Thermal
	Pacific Thermal	Pacific52™ & Pacific60™ Thermal

Applicable Altus Window System*	For Building Consents Submitted 03.11.22 - 30.04.23	
NZ Climate Zones 1 & 2	Minimum R-value 0.37	
	Joinery System	Glass Minimum Requirements
	Tasman35™	U-value of 1.10 IGU: Low E4/Argon/Clear, Thermal Spacer
	Pacific41™	
	Atlantic48™	
Southern41™ Thermal	U-value of 1.90 IGU: Low E1/Argon/Clear, Aluminium Spacer	
Pacific52™ & Pacific60™ Thermal		
NZ Climate Zones 3 & 4	Minimum R-value 0.37	
	Joinery System	Glass Minimum Requirements
	Tasman35™	U-value of 1.10 IGU: Low E4/Argon/Clear, Thermal Spacer
	Pacific41™	
	Atlantic48™	
Southern41™ Thermal	U-value of 1.90 IGU: Low E1/Argon/Clear, Aluminium Spacer	
Pacific52™ & Pacific60™ Thermal		
NZ Climate Zones 5 & 6	Minimum R-value 0.37	
	Joinery System	Glass Minimum Requirements
	Tasman35™	U-value of 1.10 IGU: Low E4/Argon/Clear, Thermal Spacer
	Pacific41™	
	Atlantic48™	
Southern41™ Thermal	U-value of 1.90 IGU: Low E1/Argon/Clear, Aluminium Spacer	
Pacific52™ & Pacific60™ Thermal		

Table 2: Construction R-values (R_{window}) of selected generic vertical windows and doors

Type of glazing	$U_g^{(1)}$	Spacer type ⁽²⁾	Example IGU ^{(3),(4)} (informative)	R_{window} ($m^2 \cdot K/W$) for different frames			
				Aluminium frame	Thermally broken aluminium frame	uPVC frame	Timber frame
Double pane	2.63	Aluminium	Glass: Clear/Clear Gas: Air	R0.26	R0.32	R0.40	R0.44
	1.90	Aluminium	Glass: Low E1/Clear Gas: Argon	R0.30	R0.39	R0.50	R0.56
	1.60	Thermally improved	Glass: Low E2/Clear Gas: Argon	R0.33	R0.42	R0.56	R0.63
	1.30	Thermally improved	Glass: Low E3/Clear Gas: Argon	R0.35	R0.46	R0.63	R0.71
	1.10	Thermally improved	Glass: Low E4/Clear Gas: Argon	R0.37	R0.50	R0.69	R0.77
	0.90	Thermally improved	Glass: Low E4/Clear Gas: Krypton	R0.40	R0.54	R0.76	R0.85
Triple pane	1.89	Thermally improved	Glass: Clear/Clear/Clear Gas: Air		R0.38	R0.50	R0.56
	1.20	Thermally improved	Glass: Low E2/Clear/Clear Gas: Argon		R0.48	R0.66	R0.74
	1.00	Thermally improved	Glass: Low E3/Clear/Clear Gas: Argon		R0.52	R0.73	R0.81
	0.70	Thermally improved	Glass: Low E3/Low E3/Clear Gas: Argon		R0.59	R0.86	R0.95
	0.60	Thermally improved	Glass: Low E4/Low E4/Clear Gas: Argon		R0.62	R0.91	R1.01

PLEASE NOTE – This table is a reproduction of Table E1.1.1, taken from H1 Energy Efficiency - Acceptable Solution H1/AS1 Energy efficiency for all housing, and buildings up to 300m² (5th Edition, Amendment 1, 4 August 2022)

For Building Consents Submitted 01.05.23 - 01.11.23	For Building Consents Submitted from 02.11.23
Minimum R-value 0.46	Minimum R-value 0.46
Joinery System	Joinery System
Tasman35™	Tasman35™
Pacific41™	Pacific41™
Atlantic48™	Atlantic48™
Southern41™ Thermal	Southern41™ Thermal
Pacific52™ & Pacific60™ Thermal	Pacific52™ & Pacific60™ Thermal
Glass Minimum Requirements	Glass Minimum Requirements
Min R-value not achievable under the Schedule Method	Min R-value not achievable under the Schedule Method
U-value of 1.30 IGU: Low E3/Argon/Clear, Thermal Spacer	U-value of 1.30 IGU: Low E3/Argon/Clear, Thermal Spacer
Minimum R-value 0.50	Minimum R-value 0.50
Joinery System	Joinery System
Tasman35™	Tasman35™
Pacific41™	Pacific41™
Atlantic48™	Atlantic48™
Southern41™ Thermal	Southern41™ Thermal
Pacific52™ & Pacific60™ Thermal	Pacific52™ & Pacific60™ Thermal
Glass Minimum Requirements	Glass Minimum Requirements
Min R-value not achievable under the Schedule Method	Min R-value not achievable under the Schedule Method
U-value of 1.10 IGU: Low E4/Argon/Clear, Thermal Spacer	U-value of 1.10 IGU: Low E4/Argon/Clear, Thermal Spacer

***Notes:**

- (1) General Guide table is based on the Schedule Method by Climate Zone, R-value and U-value as set out in H1 Energy Efficiency - Acceptable Solution H1/AS1 Energy efficiency for all housing, and buildings up to 300m² (5th Edition, Amendment 1, 4 August 2022).
- (2) General Guide table relates to the Schedule Method only and is based on a 30% glazed area. The information presented is not compliant under the Calculation Method (up to 40% glazed area) or Modelling Method (no upper limit for glazing).
- (3) Applicable dates based on consent submission, not construction dates.
- (4) As a result of the H1 changes Altus Window Systems is consolidating their residential range, the impacts of which will come into effect from November 2022. See table on pg. 8 for system updates.

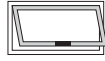

Awning Windows

Awning Windows are appropriate for both modern and traditional architecture. This suitability combined with ease of use, style, and functionality, is part of the appeal of Awning Windows. Restrictor stays can also be added to allow continuous ventilation and a degree of security.

FEATURES

- Opens outward from the bottom
- Open and close handle located at the bottom of the window frame
- Can be partly opened in the rain – will deflect some water
- Traditional style that fits any home design
- Can be used alongside other door and window formats
- Customisable height and width
- Compatible with Aluvent™ Passive Ventilation and Kleenline™ sash window frame platform cover
- Seeway™ – frameless sash windows for increased openness, ventilation and light



Casement Windows

Casement Windows suit both modern and traditional architecture. They are equal to Awning Windows in terms of strength and style, and they are designed to maximise both light and the flow of air in a streamlined, elegant design. Restrictor stays can be added to allow continuous ventilation and a degree of security. French Window options are also available with our French Window adapter allowing windows to be conveniently opened from one or both sides to further control ventilation.

FEATURES

- Opens outward from the side
- Open and close handle located on the side of the window frame
- Side opening catches wind better
- Can be used alongside other window and door formats
- Customisable height and width
- Compatible with Aluvent™ Passive Ventilation and Kleenline™ sash window frame platform cover
- French Window configuration available

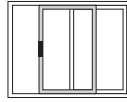

Sliding Windows

Horizontal Sliding Windows allow for non-intrusive openings onto decks and walkways, encouraging indoor-outdoor communication between guests, hosts and family members. Installed over kitchen sinks and bench tops, Sliding Windows reduce the risk of strain when you reach to open and close them.

FEATURES

- Open and close handle located on the side of the window frame
- Safest window option for busy walkways
- Ideal for openings above benchtops or kitchen sinks
- Slimline look to maximise view
- Clip latch or fully key lockable
- Available in biparting or stacking configurations
- Customisable height and width
- Optional LevelStep™ Sill
- Compatible with Aluvent™ Passive Ventilation



Bifold Windows

Bifold Windows can enhance the indoor-outdoor flow of your home. They fold easily and elegantly away allowing you to fully maximise the window opening and thereby make the most of your living spaces and views.

FEATURES

- Creates a bigger opening than a traditional window
- Top hung and Bottom rolling options (system dependant)
- Top hung comes with a flush sill for a finished look and allows easy cleaning
- A Foldback™ bifold option allows the windows to fold flat against the cladding, giving unobstructed open access (Top hung only)
- Anti Rub System keeps the panel away from the frame providing a seamless gliding mechanism
- Multipoint locking
- Customisable in height and width



Ranchslider™ (Inside Slider)

The classic kiwi Ranchslider™ Sliding Door has a single panel that slides away behind a fixed panel leaving no intrusive sections to obstruct access or the view. And you can choose to incorporate either fixed or opening windows into the non-sliding section. Your Ranchslider™ can also be configured with sliding panels that meet at a corner without the need for a pillar; they can also slide into a cavity or over an exterior wall.

FEATURES

- Optional LevelStep™ Sill (pictured) allows a flush level entry removing all potential trip hazards
- Smoothtech™ Chevron track ensures easy glide sliding doors
- ACT Interlocker softener reduces the sound made when the sliding door engages
- Optional Sightline Adaptor brings the fixed pane bottom rail up level with the sliding panels creating a seamless sight line



Ranchstacker™ (Inside Stacker)

A Ranchstacker™ door is an extended classic kiwi Ranchslider™ Sliding Door. It has two or more panels that slide the same way behind a fixed panel, leaving no intrusive sections to obstruct access or the view. And you can choose to incorporate either fixed or opening windows into the non-sliding section. Ranchstacker™ Sliding Doors can also be configured with sliding panels that meet at a corner without the need for a pillar; they can also slide into a cavity or over an exterior wall.

FEATURES

- Optional LevelStep™ Sill allows a flush level entry removing all potential trip hazards
- Smoothtech™ Chevron track ensures easy glide sliding doors
- ACT Interlocker softener reduces the sound made when the sliding doors come together and engage



Euroslider™ (Outside Slider)

The Euroslider™ is a beautifully clean design. Unlike traditional sliding doors, the Euroslider™ has no lower channels or cavities to collect unsightly dirt and debris. The Euroslider™ can also be configured with sliding panels that meet at a corner without the need for a pillar; they can also slide into a cavity or over an exterior wall. The Euroslider™ is perfect for harsh conditions making it suitable for homes located near the beach or the bush. It is also the smoothest sliding door in our entire range.

FEATURES

- High performance threshold seal provides exceptional performance to suit any weather conditions
- Smoothtech™ Chevron track ensures easy glide sliding doors
- ACT Interlocker softener reduces the sound made when the sliding door engages

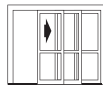

Eurostacker™ (Outside Stacker)

The Eurostacker™ sliding door has two or more moving panels making it ideal for wide openings and blurring the line between indoor and outdoor spaces.

FEATURES

- High performance threshold seal provides exceptional performance to suit any weather conditions
- Flush sill for easy cleaning and a modern look
- Smoothtech™ Chevron track ensures easy glide sliding doors
- ACT Interlocker softener reduces the sound made when the sliding doors come together and engage

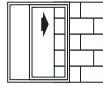

Overwall And Cavity Corner Sliding & Stacking Doors

Overwall and Cavity Sliders have the ability to make whole walls disappear when open while causing minimal disruption of the view when closed. They can be configured with sliding doors that meet at a corner without the need for a pillar. Aesthetic detailing is key, with features such as equal height rails, square edges for clean lines and the optional Levelstep™ Sills available.

FEATURES

- Smoothtech™ Chevron track ensures easy glide sliding doors
- ACT Interlocker softener reduces the sound made when the sliding doors come together and engage



Bi-Fold And Foldback™ Bifold Doors

Bifold Doors fold away concertina-style to essentially remove the barrier between indoors and out, maximising the amount of open door space. The Foldback™ bifold option goes a step further with the doors folding back 180° to lay flat against the building, creating even more space whilst removing a possible obstruction.

FEATURES

- Anti Rub System keeps the panel away from the frame providing a seamless gliding mechanism
- ART Bifold Door Aligner – holds each panel in perfect alignment throughout the bifold motion
- Continuous panel seals at all bifold hinged junctions to maintain weatherproofing and keep the rain out
- Multipoint locking



French & Hinged Doors

The traditional design and form of French Doors complement any home. The door panels come in a range of sizes to suit the style and proportions of your home. French Doors can be conveniently opened one side at a time to control traffic flow or ventilation depending on the situation, or opened together to provide unobstructed access and views.

FEATURES

- Sidelights and overlights are possible
- Parliament hinges available to allow for 180° opening over brick cladding

Tasman35™

Suitable for most family homes, **Tasman35™** combines traditional and modern aesthetic options with practical functionality.

The **Tasman35™** System offers windows and doors that are fit for purpose, delivering quality solutions and cost-efficient ways to achieve increased indoor/outdoor flow. Door units within the **Tasman35™** System can be up to 2.4m high, with sliding panels weighing up to 150kg. The system can accommodate double glazed units up to 26mm in thickness and is available in a traditional scalloped frame or a sleek flat faced profile.



Pacific41™

Typically preferred for use in larger high quality family homes, the **Pacific41™** System is ideal for architecturally designed projects situated in difficult locations or harsh environments.

The **Pacific41™** System complements well-chosen materials, fixtures and fittings and can easily accommodate large glazing units where the building's design calls for vast expanses of glass. The unit heights can be up to 2.6m, or higher depending on unit type and application, and the minimum wind zone rating for most **Pacific41™** products is Extreme. The System's inherent sturdiness and adaptability means it is also ideal for low level commercial applications such as schools or medium density housing projects, from terraced houses to apartments.



Atlantic48™

When your project involves a grand design, edgy architecture or an extreme location the **Atlantic48™** System is the one you want.

Designed to reach higher and span further than any other joinery system, **Atlantic48™** is capable of exceeding 3.0m in height, depending on unit type and application. This is the go-to-system when the only acceptable outcome is the flawless execution of an architectural vision combined with the seamless fusion of high end materials, fixtures and fittings, regardless of location.





Southern41™ Thermal

Southern41™ Thermal is a 41mm residential aluminium joinery system with a unique thermal break built into the frame to improve the insulation of your home, making it ideal for use in any climate.

The unique **Southern41™** thermal break not only builds on the impressive insulating properties of double glazing, it also delivers unparalleled structural strength whilst combining traditional and modern aesthetic options. All to provide you a comfier, healthier home, all year round.



Pacific52™ Thermal

Pacific52™ Thermal is a 52mm thermally broken system offering improved insulation, noise reduction, and a decrease in the amount of condensation forming on the surface of the glass – the perfect solution for a more comfortable, warmer and drier home.

Like glass, aluminium is also highly conductive. So, in summertime for example, aluminium window frames capture heat from the sun and disseminate it throughout your house. Extra energy is then required to keep the indoors cool and comfortable.

Pacific52™ Thermal solves this problem with its thermally broken frame, which has a thermal nylon barrier built into it to prevent heat moving from the front of the frame to the inside of your home. The break literally stops heat entering your house making the inside cooler, more comfortable and potentially more energy efficient.

Because we are in a transition period brought about by changes to section H1 of the New Zealand Building Code, the Southern41™ and Pacific52™ Thermal Systems may not be available in some regions until 2023. Please discuss availability with your local Rylock consultant.

* Higher spans may be possible. Please contact your local Rylock consultant for more information.





Tasman35™

With innovation as its cornerstone,
Tasman35™ performs beyond expectation.



Tasman35™



The **Tasman35™** system is ideal for most family homes.

The Tasman35™ system provides structural performance and dependable weather protection, whilst combining traditional and modern aesthetic options entrenched with practical functionality.

All products within the range can accommodate single or double glazed units up to 26mm in thickness.

Tasman35™ window and door units come with either a traditional scalloped frame, or a modern and sleek flat faced frame profile, the latter of which is designed to blend seamlessly with our Pacific41™ and Atlantic48™ systems, if required.

Door units within the Tasman35™ System can be up to 2.4m* high, with sliding panels weighing up to 150kg and hinged panels weighing up to 80kgs, providing large glass openings for impressive access and uninterrupted views.

The Tasman35™ System can accommodate almost any combination of window and door configuration. Innovative products such as the iconic Ranchslider™, functional Levelstep™ and the premium Euroslider™ are all available within the system.

HEIGHT



* Higher spans may be possible. Please contact your local Rylock consultant for more information.



Fixed light window

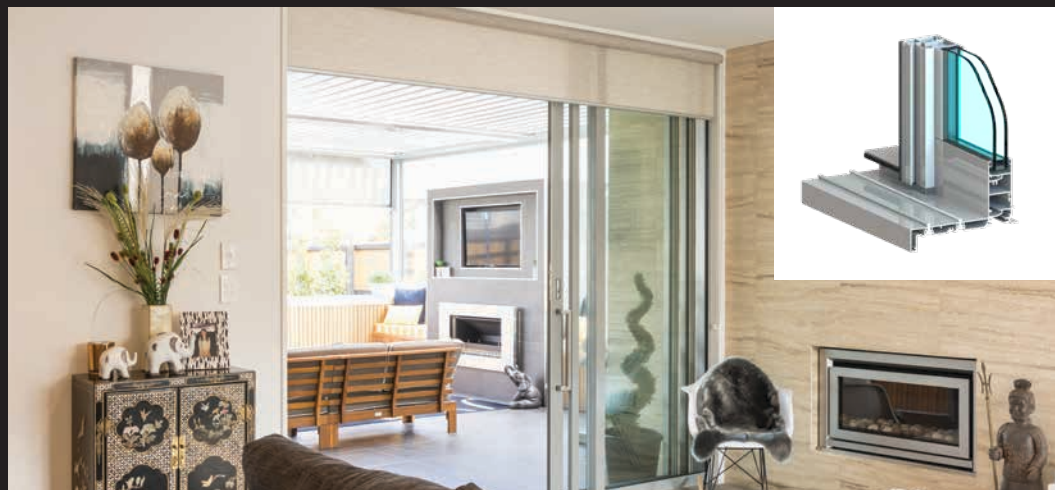

Eurostacker™ door



Features & Benefits:

- Mix and Match components from the Tasman35™, Pacific41™ and Atlantic48™ systems interchangeably on the same build project, making it possible to upgrade in certain areas or rooms of your home where you would like to achieve a high-end finish; all whilst maintaining the same visual aesthetic and level of performance
- Pressurefit Beads facilitate faster implementation of your glazing system along with higher performance seals and cleaner lines
- Our patented connection system removes the need to drill holes in the window frame which could affect the overall integrity of the window by lowering its thermal performance and weather tightness
- With innovation as its cornerstone, it is no surprise that the Tasman35™ System provides access to a wide range of market leading residential window and door components, such as the Euroslider™, the Eurostacker™ and Kleenline™ Sill cover for a premium finished window look that is easy to clean and maintain and Aluvent™ Passive Ventilation for a more breathable home

Tasman35™ Individual Product H1 Detail

The New Zealand Building Code requires windows and doors to meet specific energy efficiency performance levels known as R-values to achieve compliance. Required R-values vary by climate zone and can be achieved through an appropriate combination of glass (U-value), IGU elements (insulated glazing unit), spacer type and frame type. The table below sets out the minimum glass and IGU requirements for the Tasman35™ System based on the Schedule Method. Please use in conjunction with the Climate Zone map and Construction R-values table on pages 7 and 8.

Tasman35™ System*	For Building Consents Submitted 03.11.22 - 30.04.23	For Building Consents Submitted 01.05.23 - 01.11.23	For Building Consents Submitted from 02.11.23
NZ Climate Zones 1 & 2	Minimum R-value 0.37 Glass Minimum Requirements: U-value of 1.10 IGU: Low E4/Argon/Clear, Thermal Spacer		Minimum R-value 0.46 Min R-value not achievable under the Schedule Method
	Minimum R-value 0.37 Glass Minimum Requirements: U-value of 1.10 IGU: Low E4/Argon/Clear, Thermal Spacer	Minimum R-value 0.46 Min R-value not achievable under the Schedule Method	
NZ Climate Zones 3 & 4	Minimum R-value 0.37 Glass Minimum Requirements: U-value of 1.10 IGU: Low E4/Argon/Clear, Thermal Spacer	Minimum R-value 0.50 Min R-value not achievable under the Schedule Method	
	Minimum R-value 0.37 Glass Minimum Requirements: U-value of 1.10 IGU: Low E4/Argon/Clear, Thermal Spacer	Minimum R-value 0.50 Min R-value not achievable under the Schedule Method	

*Notes: (1) Demonstrating compliance with the Schedule Method should be done in conjunction with Table E1.1.1 as reproduced on page 9.
 (2) Table based on the Schedule Method by Climate Zone, R-value and U-value as set out in H1 Energy Efficiency - Acceptable Solution H1/AS1 Energy efficiency for all housing, and buildings up to 300m² (5th Edition, Amendment 1, 4 August 2022).
 (3) Table based on Schedule Method (30% glazed area) only. Information presented is not compliant under Calculation or Modelling methods.
 (4) Applicable dates based on consent submission, not construction dates.
 (5) Post November 2023 using the Schedule Method Tasman35™ System will only be suitable for non-habitable spaces such as sheds and garaging.



Biparting Ranchslider™

Sliding and Stacking Doors

- Doors can be up to 2.4m high x 1.4m wide with sliding panels weighing up to 150kg
- Euroslider™ and Eurostacker™ premium options available with flat sill feature designed for ease of cleaning in high dust and debris areas
- Classic kiwi Ranchslider™ and Ranchstacker™ styles available with optional Levelstep™ Sills for a true flush threshold
- Door concealment options such as Overwall, Cavity and Corner sliders available with each designed to maximise access and views
- Choose from Biparting and Corner Biparting options where moving doors meet in the centre, creating unique openings and a feeling of pillarless space

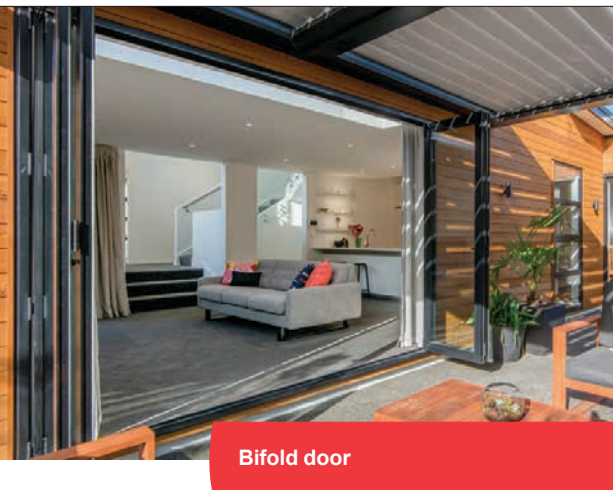
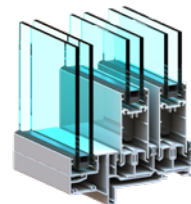

Bifold door

Bifold Doors

- Bifold panels can be up to 2.4m high x 0.9m wide, with panels weighing up to 55kg
- Individual panels are 45mm thick, offering increased strength for better performance in high wind zones
- Open in and open out options
- Top Hung doors conceal the rolling gear in the top of the door, protecting it from dust and harm, allowing for a flush sill to be inserted at the bottom of the unit ensuring easy maintenance and a clean look
- Bottom Rolling doors have the rolling mechanism at the bottom of the panel making them better suited for larger spans across wide openings



French Door

French and Hinged Doors

- French and Hinged Doors can be up to 2.4m high x 1m wide with panels weighing up to 55kg
- Optional flush sill feature for low trip hazard, a clean look and easy maintenance in high dust and debris areas
- Optional side light ventilation

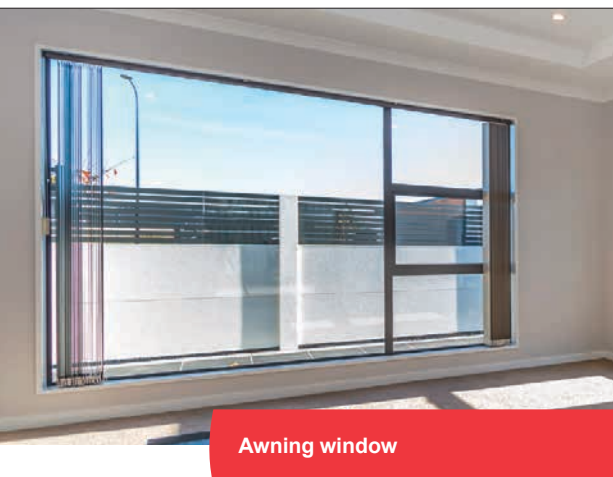
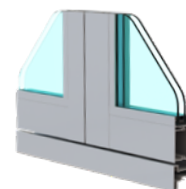

Awning window

Awning & Casement Windows

- Awning and Casement window panes can be up to 1.6m high x 0.8m wide
- Seeway™ frameless sash windows without a transom – the horizontal bar separating the individual panes of glass – are available in both Awning and Casement format and are a unique way to increase light and create a feeling of openness
- Kleenline™ – Sash window frame platform cover, for a premium finished look that is easy to clean and maintain
- Flush-fit sash windows close inside the window frame offering a premium finished look

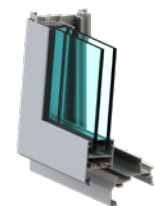



Pacific41™

Designed in New Zealand specifically for local conditions, the Pacific41™ System draws its inspiration from classic kiwi values such as innovation, strength and reliability, placing it at the heart of New Zealand's Architectural window and door market.



Pacific41™



The Pacific41™ system is the preferred option for large family homes with an architectural focus on high quality finishes in locations where conditions can be extreme.

The System's visual and aesthetic appeal, glazing capability and strength of its internal components make it ideal for anyone taking a step up in terms of the design, location and size of their home.

All products within the range can accommodate double glazed units up to 30mm in thickness, a must for larger format windows and doors. The system's modern and sleek flat faced frame profile is available across all products within the range and can be seamlessly integrated with our Tasman35™ and Atlantic48™ systems, if required.

Door unit sizes within the Pacific41™ System can be up to 2.6m* high, with sliding panels weighing up to 200kg and hinged panels weighing up to 80kgs, providing more-than-impressive large glass openings to facilitate access and enhance views.

The Pacific41™ System can accommodate almost any combination of window and door configuration. Innovative products such as the iconic Ranchslider™, functional Levelstep™, premium Euroslider™, Overwall, Cavity or Corner slider and the Foldback™ bifold are all available within the system. And all can be tailored to meet the requirements of your project.

HEIGHT



* Higher spans may be possible. Please contact your local Rylock consultant for more information.



Fixed light windows



Euroslider™ door



Features & Benefits:

- Mix and Match components from the Tasman35™, Pacific41™ and Atlantic48™ systems interchangeably on the same build project, making it possible to upgrade in certain areas or rooms of your home where you would like to achieve a high-end finish; all whilst maintaining the same visual aesthetic and level of performance
- Pressurefit Beads facilitate faster implementation of your glazing system along with higher performance seals and cleaner lines
- Our patented connection system removes the need to drill holes in the window frame which could affect the overall integrity of the window by lowering its thermal performance and weather tightness
- The Pacific41™ System sits at the heart of New Zealand’s Architectural windows and doors market, so you would naturally expect access to a wide range of market leading residential window and door components, such as: Euroslider™, Eurostacker™, Overwall, Cavity and Corner sliding doors that simply slide from view, and Foldback™ bifold doors which fold back flush against the building to create even more outdoor space

Pacific41™ Individual Product H1 Detail

The New Zealand Building Code requires windows and doors to meet specific energy efficiency performance levels known as R-values to achieve compliance. Required R-values vary by climate zone and can be achieved through an appropriate combination of glass (U-value), IGU elements (insulated glazing unit), spacer type and frame type. The table below sets out the minimum glass and IGU requirements for the Pacific41™ System based on the Schedule Method. Please use in conjunction with the Climate Zone map and Construction R-values table on pages 7 and 8.

Pacific41™ System*	For Building Consents Submitted 03.11.22 - 30.04.23	For Building Consents Submitted 01.05.23 - 01.11.23	For Building Consents Submitted from 02.11.23
NZ Climate Zones 1 & 2	Minimum R-value 0.37 Glass Minimum Requirements: U-value of 1.10 IGU: Low E4/Argon/Clear, Thermal Spacer		Minimum R-value 0.46 Min R-value not achievable under the Schedule Method
NZ Climate Zones 3 & 4	Minimum R-value 0.37 Glass Minimum Requirements: U-value of 1.10 IGU: Low E4/Argon/Clear, Thermal Spacer	Minimum R-value 0.46 Min R-value not achievable under the Schedule Method	
NZ Climate Zones 5 & 6	Minimum R-value 0.37 Glass Minimum Requirements: U-value of 1.10 IGU: Low E4/Argon/Clear, Thermal Spacer	Minimum R-value 0.50 Min R-value not achievable under the Schedule Method	

*Notes: (1) Demonstrating compliance with the Schedule Method should be done in conjunction with Table E1.1.1 as reproduced on page 9.
 (2) Table based on the Schedule Method by Climate Zone, R-value and U-value as set out in H1 Energy Efficiency - Acceptable Solution H1/AS1 Energy efficiency for all housing, and buildings up to 300m² (5th Edition, Amendment 1, 4 August 2022).
 (3) Table based on Schedule Method (30% glazed area) only. Information presented is not compliant under Calculation or Modelling methods.
 (4) Applicable dates based on consent submission, not construction dates.
 (5) Post November 2023 using the Schedule Method Pacific41™ System will only be suitable for non-habitable spaces such as sheds and garaging.

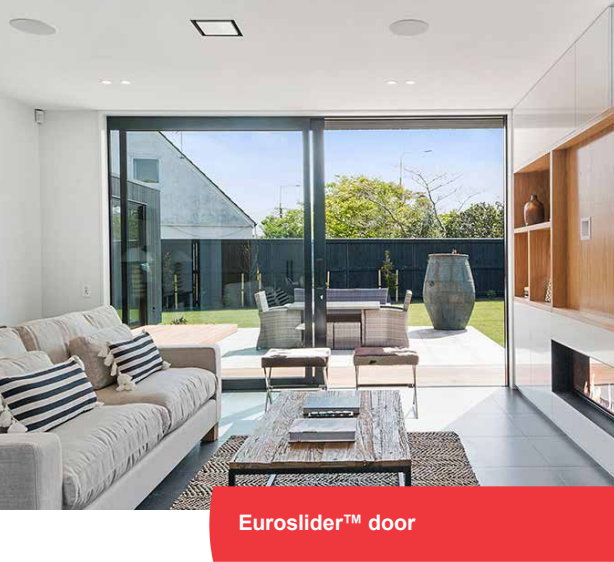

Euroslider™ door

Sliding and Stacking Doors

- Doors can be up to 2.6m high x 1.6m wide with sliding panels weighing up to 160kg
- Euroslider™ and Eurostacker™ premium options available with flat sill feature designed for ease of cleaning in high dust and debris areas
- Classic kiwi Ranchslider™ and Ranchstacker™ styles available with optional Levelstep™ Sills for a true flush threshold
- Door concealment options such as Overwall, Cavity and Corner sliders available with each designed to maximise access and views
- Choose from Biparting and Corner Biparting options where moving doors meet in the centre, creating unique openings and a feeling of pillarless space

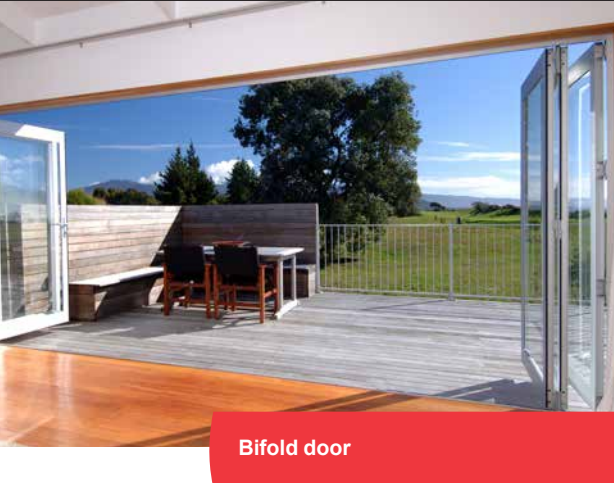

Bifold door

Bifold, Foldback™ Bifold Doors

- Bifold and Foldback™ Bifold panels can be up to 2.6m high x 0.9m wide
- Individual panels are 50mm thick, making them incredibly strong and able to provide real security in higher wind zones
- The patented Foldback™ Head allows the panels to fold 180° and lay flat against the clad wall to create even more outdoor space
- Top Hung doors protect the rolling gear from dust and harm, allowing for a flush sill to be inserted at the bottom of the unit ensuring easy maintenance and a clean look
- Bottom Rolling doors have the rolling mechanism at the bottom of the panel making them better suited for larger spans across wide openings

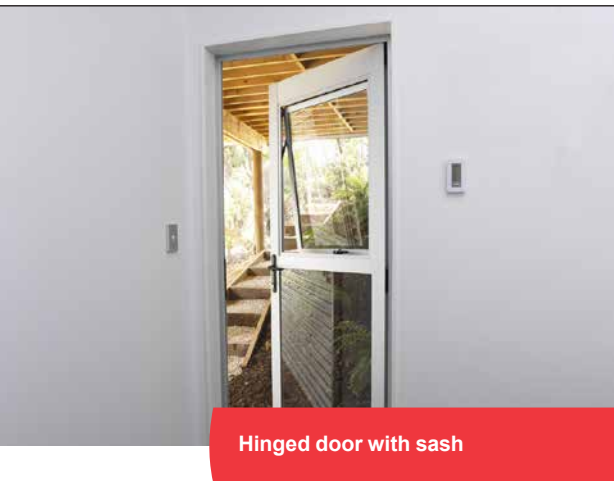

Hinged door with sash

French and Hinged Doors

- French and Hinged Doors can be up to 2.4m high x 1m wide, rigidly braced with a unique built-in glass blocking system
- Optional flush sill feature for low trip hazard, a clean look and easy maintenance in high dust and debris areas
- Optional side light ventilation

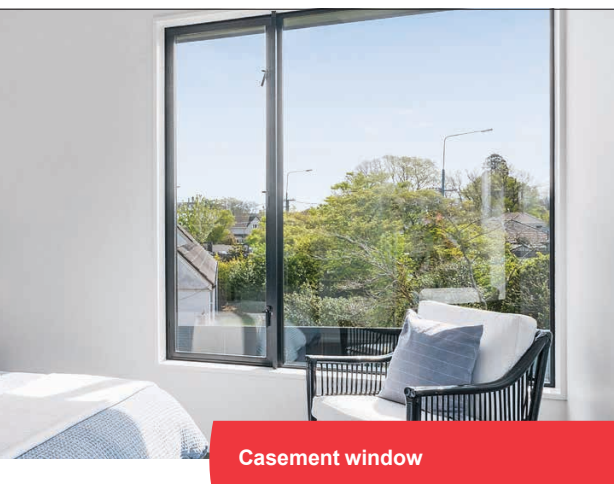

Casement window

Awning & Casement Windows

- Awning and Casement window panes can be up to 1.8m high x 0.9m wide
- Seismic frame options are available
- Kleenline™ – Sash window frame platform cover, for a premium finished look that is easy to clean and maintain
- Flush-fit sash windows close inside the window frame offering a premium finished look



Atlantic48™

This is the system for grand designs, majestic homes, edgy architecture, extreme locations, and super weights. It's also ideal for integration into commercial applications.

Atlantic48™



Our residential architecture has come of age. Increasingly, New Zealanders have a sophisticated knowledge and appreciation of how good design can shape the way we live. Homeowners are stretching the limits: they're looking for confident, exciting architecture and products where a stylish materiality works hand-in-hand with supreme functionality.

Large-scale homes demand expansive ideas and bold solutions and the Atlantic48™ System delivers. This range of high-end high-spec windows and doors is a robust system that can carry the load with ease. A significant maximum rolling weight per panel means there are myriad configuration options: higher and wider openings provide bigger views and make even bigger design statements.

So, when a standard response just won't do, go beyond the expected and expand your design horizons. Because although pioneer of modern architecture Mies van Der Rohe proclaimed "less is more", there are times when, undernably, more is better.

Atlantic48™ perfectly complements all high end materials, fixtures and fittings. Afterall, a home of great quality, style or scale deserves to be fitted out with products of the highest specifications.

The Atlantic48™ System is capable of reaching up to 3.0m* in height, and can go even higher depending on unit type and application. The system also exceeds the extreme wind zone requirements making it the ideal system for difficult or challenging locations, from a windy coastal cliff top site through to a small edgy central city pied-à-terre.

The system integrates seamlessly with our other product systems: Tasman35™ and Pacific41™ as well as the Flush Glaze and Shop Front systems (part of our Baltic™ Commercial range), to ensure each project remains true to and delivers on its original vision.

HEIGHT



* Higher spans may be possible. Please contact your local Rylock consultant for more information.

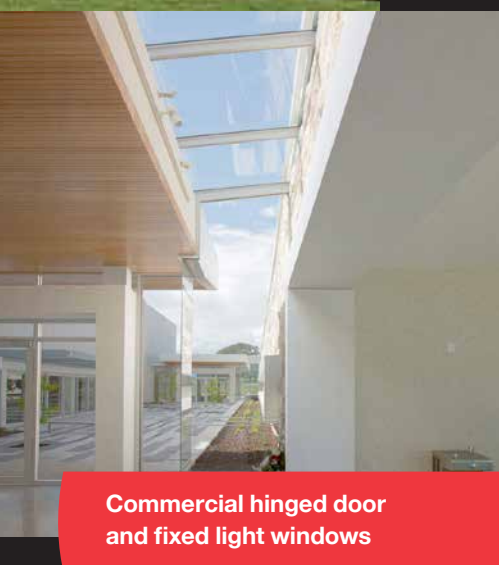

Commercial hinged door and fixed light windows

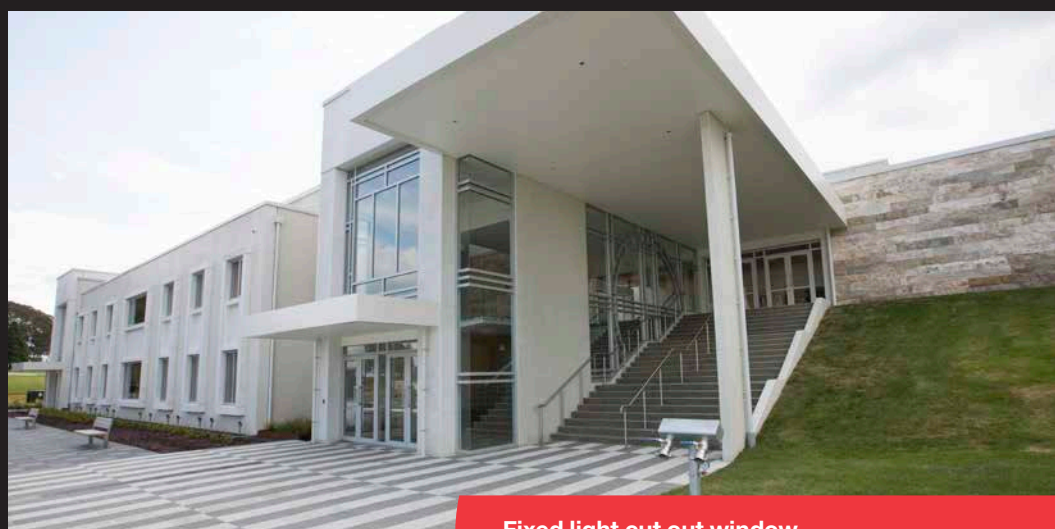

Fixed light cut out window

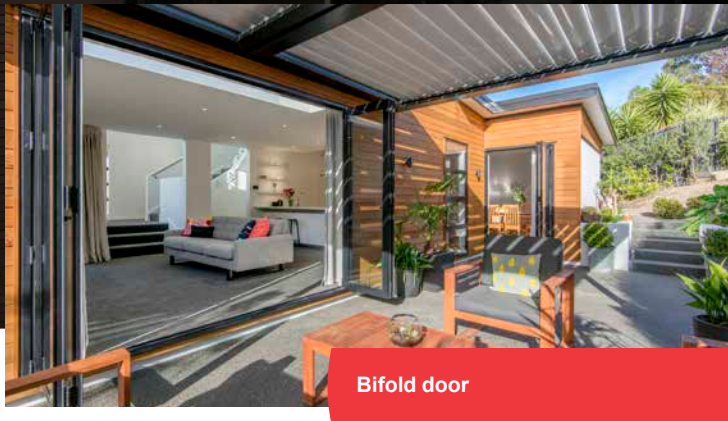

Bifold door

Features & Benefits:

- Can accommodate double glazed units up to 36mm in thickness – a must for larger format windows and doors
- Seamless transition from frames to Awning Windows, Hinged Doors, Sliding and Stacking Doors with no width build up
- Performance beyond Extreme wind ratings (for some products)
- Capacity to deliver generous glazing expanses with low-E double glazed upgrade options available
- Sills and sill trays have a continuous drainage gap (rather than holes or slots) allowing for true pressure equalisation
- Bifold and French Door Hinges use lock-up plate technology for easy adjustment
- All stainless steel or aluminium operating gear
- Designed, made and tested in New Zealand specifically for local conditions

Atlantic48™ Individual Product H1 Detail

The New Zealand Building Code requires windows and doors to meet specific energy efficiency performance levels known as R-values to achieve compliance. Required R-values vary by climate zone and can be achieved through an appropriate combination of glass (U-value), IGU elements (insulated glazing unit), spacer type and frame type. The table below sets out the minimum glass and IGU requirements for the Atlantic48™ System based on the Schedule Method. Please use in conjunction with the Climate Zone map and Construction R-values table on pages 7 and 8.

Atlantic41™ System*	For Building Consents Submitted 03.11.22 - 30.04.23	For Building Consents Submitted 01.05.23 - 01.11.23	For Building Consents Submitted from 02.11.23
NZ Climate Zones 1 & 2	Minimum R-value 0.37 Glass Minimum Requirements: U-value of 1.10 IGU: Low E4/Argon/Clear, Thermal Spacer		Minimum R-value 0.46 Min R-value not achievable under the Schedule Method
NZ Climate Zones 3 & 4	Minimum R-value 0.37 Glass Minimum Requirements: U-value of 1.10 IGU: Low E4/Argon/Clear, Thermal Spacer	Minimum R-value 0.46 Min R-value not achievable under the Schedule Method	
NZ Climate Zones 5 & 6	Minimum R-value 0.37 Glass Minimum Requirements: U-value of 1.10 IGU: Low E4/Argon/Clear, Thermal Spacer	Minimum R-value 0.50 Min R-value not achievable under the Schedule Method	

*Notes: (1) Demonstrating compliance with the Schedule Method should be done in conjunction with Table E1.1.1 as reproduced on page 9.
 (2) Table based on the Schedule Method by Climate Zone, R-value and U-value as set out in H1 Energy Efficiency - Acceptable Solution H1/AS1 Energy efficiency for all housing, and buildings up to 300m² (5th Edition, Amendment 1, 4 August 2022).
 (3) Table based on Schedule Method (30% glazed area) only. Information presented is not compliant under Calculation or Modelling methods.
 (4) Applicable dates based on consent submission, not construction dates.
 (5) Post November 2023 using the Schedule Method Atlantic48™ System will only be suitable for non-habitable spaces such as sheds and garaging.



Euroslider™ door

Sliding and Stacking Doors and Windows

- Doors can be up to 3.0m high with sliding panels weighing up to 250kg
- Euroslider™ – beautifully designed premium sliding door perfectly suited to harsh conditions; comes with flush sill feature making cleaning easy, especially in high dust and debris areas
- Classic kiwi Ranchslider™ is available with optional Levelstep™ Sills for a true flush threshold
- Door concealment options such as Overwall, Cavity and Corner sliders available with each designed to maximise access and views
- Choose from Biparting and Corner Biparting options where moving doors meet in the centre, creating unique openings and a feeling of pillar-less space
- Performance beyond Extreme wind ratings for Euroslider™ doors

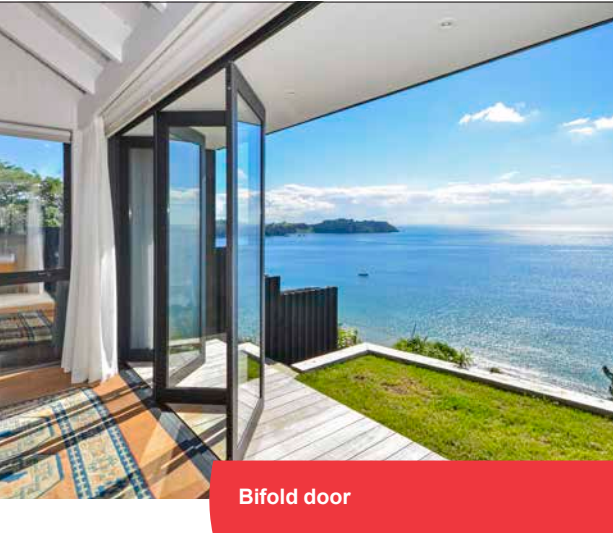

Bifold door

Bifold, Foldback™ Bifold Doors and Windows

- Bifold and Foldback™ bifold panels can be up to 2.4m high with Bifold panels weighing up to 80kg; Foldback™ bifold panels up to 50kg
- Maximum number of Bifold panels: Up to twelve – six each way; Foldback™ bifold panels: Up to six – three each way
- The patented Foldback™ Head allows the panels to fold 180° and lay flat against the clad wall to create even more outdoor space
- Top Hung doors protect the rolling gear from dust and harm, allowing for a flush sill to be inserted at the bottom of the unit ensuring easy maintenance and a clean look
- Bottom Rolling doors have the rolling mechanism at the bottom of the panel making them better suited for larger spans across wide openings
- Tested to 50,000 cycles



French Doors with sidelight casement windows including Colonial Bars

French and Hinged Doors and Windows

- Doors can be up to 3.0m high with Hinged panels weighing up to 80kg
- Optional flush sill feature for low trip hazard, a clean look and easy maintenance in high dust and debris areas

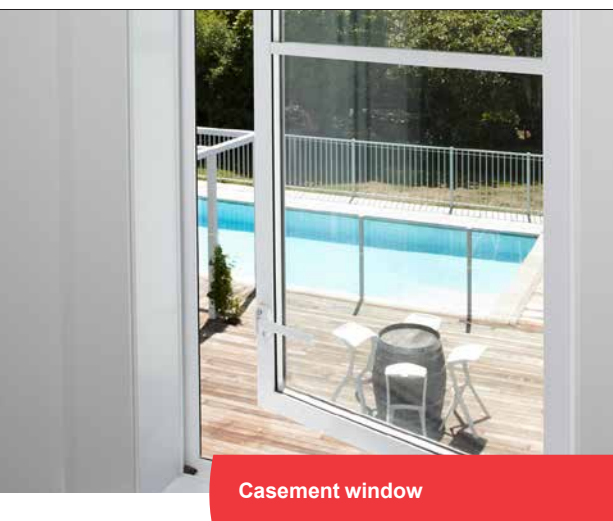

Casement window

Awning and Casement Windows

- Seismic frame options with Inter-storey deflection available
- Aluvent™ Passive Ventilation – can be added to any fixed, or opening panel
- Kleenline™ – Sash window frame platform cover, for a premium finished look that is easy to clean and maintain
- Flush-fit sash windows close inside the window frame offering a premium finished look



Southern41™ Thermal

Continuous innovation and a focus on creating healthier homes form the core of the Southern41™ Thermal System.

Because we are in a transition period brought about by changes to section H1 of the New Zealand Building Code, the Southern41™ Thermal System may not be available in some regions until 2023. Please discuss availability with your local Rylock consultant.

Southern41™ Thermal



Southern41™ Thermal – a unique product for a healthy home.

Just as double glazing prevents warmth or coldness from escaping through glass, the thermal break in an aluminium frame does the same for your joinery by stopping any heat transfer via the metal. The result is an increased R-value enabling Southern41™ Thermal to provide maximum protection against condensation making it easier for you to maintain your home at an optimal 'healthy home' minimum temperature of 18° Celsius, not to mention the significant energy savings on offer.

The R-value is a measure of how well a product insulates – the greater the value the greater the insulation properties.

But what is it exactly that makes Southern41™ Thermal different from other thermally broken products available in New Zealand?

As they say, the devil is in the detail. Southern41™ thermally broken joinery is made using the 'Pour and Debridge' manufacturing method. This involves filling (the 'Pour') a channel designed into the aluminium frame with a resin. The back of the channel is then milled out (the 'Debridge') to sever the link between the front and the back of the aluminium and create a 5mm thermal break in the frame.

The resin is incredibly strong so the Southern41™ Thermal System can withstand virtually any climatic

conditions, including Extra High wind zones. In fact, Southern41™ Thermal is so strong it exhibits the same performance characteristics of a regular aluminium section. This great strength also makes Southern41™ Thermal suitable for larger windows and doors, up to 2.4m* in height.

All products within the Southern41™ Thermal range can accommodate double glazed units up to 30mm in thickness.

The Southern41™ Thermal System can accommodate almost any combination of window and door configuration, while the framing itself has a sleek square profile, not rounded, to suit modern architectural aesthetics. Innovative products such as the iconic Ranchslider™, functional Levelstep™, and the premium Euroslider™ are all available within the system.

HEIGHT

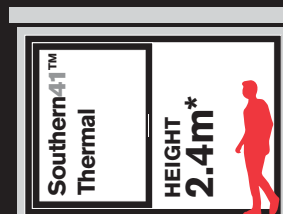

* Higher spans may be possible. Please contact your local Rylock consultant for more information.

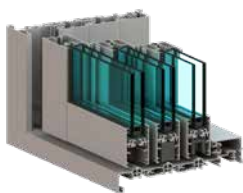

Eurostacker™ door

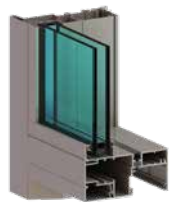
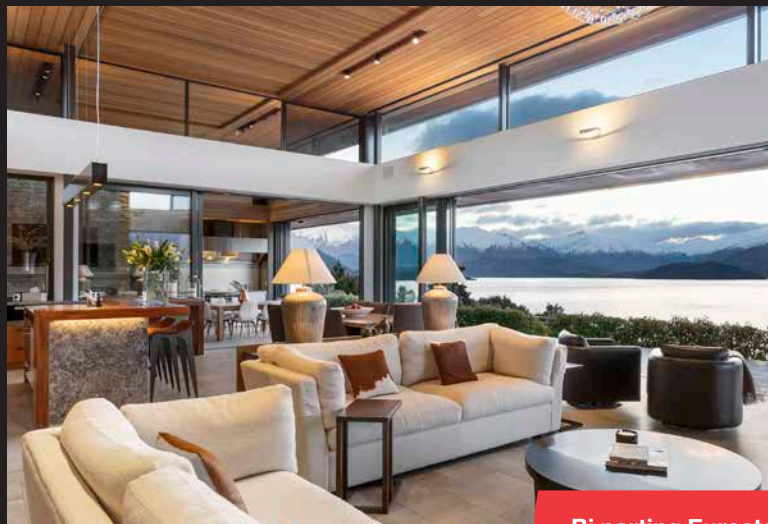

Bi parting Eurostacker™ door



Ranchstacker™ door



Features & Benefits:

- Can accommodate double glazed units up to 30mm in thickness
- Year-round comfort – in winter Southern41™ Thermal helps prevent the cold from entering your house (or the warmth from escaping); in summer it works the same way by keeping the hot air out and the cooler air inside
- Enhanced protection against condensation – even with double glazing, condensation can still form on joinery or the edges of the glass if there's no thermal break
- Energy savings – by combining standard double glazing with Southern41™ Thermal aluminium framing you'll increase the R-value of your windows, meaning it'll require less energy to maintain the optimal 'healthy home' temperature in all seasons
- Larger frames – Southern41™ Thermal is built to suit larger windows and doors, making it perfect for creating superb indoor-outdoor flow
- Stylish square profile to suit modern architectural aesthetics

Southern41™ Thermal Individual Product H1 Detail

The New Zealand Building Code requires windows and doors to meet specific energy efficiency performance levels known as R-values to achieve compliance. Required R-values vary by climate zone and can be achieved through an appropriate combination of glass (U-value), IGU elements (insulated glazing unit), spacer type and frame type. The table below sets out the minimum glass and IGU requirements for the Southern41™ System based on the Schedule Method. Please use in conjunction with the Climate Zone map and Construction R-values table on pages 7 and 8.

Southern41™ System*	For Building Consents Submitted 03.11.22 - 30.04.23	For Building Consents Submitted 01.05.23 - 01.11.23	For Building Consents Submitted from 02.11.23
NZ Climate Zones 1 & 2	Minimum R-value 0.37 Glass Minimum Requirements: U-value of 1.90 IGU: Low E1/Argon/Clear, Aluminium Spacer		Minimum R-value 0.46 Glass Minimum Requirements: U-value of 1.30 IGU: Low E3/Argon/Clear, Thermal Spacer
		Minimum R-value 0.46 Glass Minimum Requirements: U-value of 1.30 IGU: Low E3/Argon/Clear, Thermal Spacer	
NZ Climate Zones 3 & 4	Minimum R-value 0.37 Glass Minimum Requirements: U-value of 1.90 IGU: Low E1/Argon/Clear, Aluminium Spacer	Minimum R-value 0.46 Glass Minimum Requirements: U-value of 1.30 IGU: Low E3/Argon/Clear, Thermal Spacer	
			Minimum R-value 0.50 Glass Minimum Requirements: U-value of 1.10 IGU: Low E4/Argon/Clear, Thermal Spacer
NZ Climate Zones 5 & 6	Minimum R-value 0.37 Glass Minimum Requirements: U-value of 1.90 IGU: Low E1/Argon/Clear, Aluminium Spacer	Minimum R-value 0.50 Glass Minimum Requirements: U-value of 1.10 IGU: Low E4/Argon/Clear, Thermal Spacer	

*Notes: (1) Demonstrating compliance with the Schedule Method should be done in conjunction with Table E1.1.1 as reproduced on page 9.
 (2) Table based on the Schedule Method by Climate Zone, R-value and U-value as set out in H1 Energy Efficiency - Acceptable Solution H1/AS1 Energy efficiency for all housing, and buildings up to 300m² (5th Edition, Amendment 1, 4 August 2022).
 (3) Table based on Schedule Method (30% glazed area) only. Information presented is not compliant under Calculation or Modelling methods.
 (4) Applicable dates based on consent submission, not construction dates.



Sliding and Stacking Doors and Windows

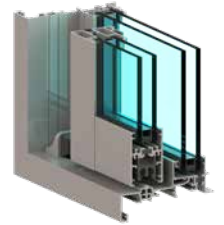

- Sliding or Stacking Doors can be up to 2.4m high with sliding panels weighing up to 220kg
- Sliding panels can accommodate insulating glass units up to 26mm in thickness
- Minimum number of panels: Two panels – one fixed, one moving
- Maximum number of panels: As many as is practical, all sliding one way or bi-parting from the centre

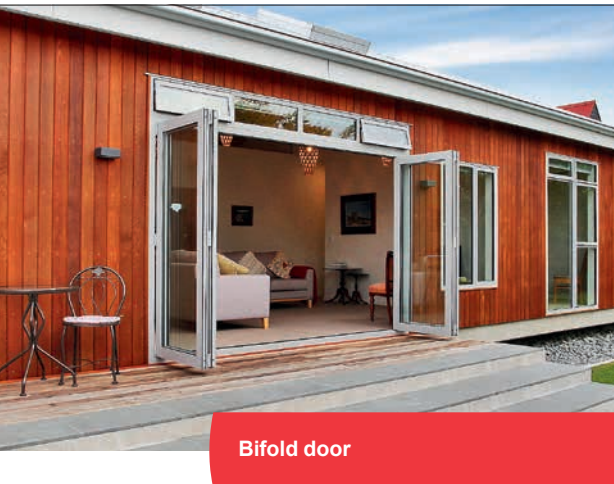

Bifold Doors and Windows

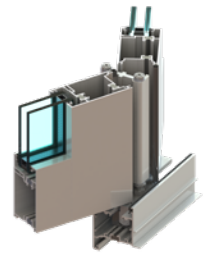

- Bifold Doors can be up to 2.4m high with folding panels weighing up to 60kg
- Panels are 50mm thick making them incredibly strong and able to provide real security in higher wind zones
- Flush beaded appearance
- Top Hung doors protect the rolling gear from dust and harm, allowing for a flush sill to be inserted at the bottom of the unit ensuring easy maintenance and a clean look
- Bottom Rolling doors have the rolling mechanism at the bottom of the panel making them better suited for larger spans across wide openings

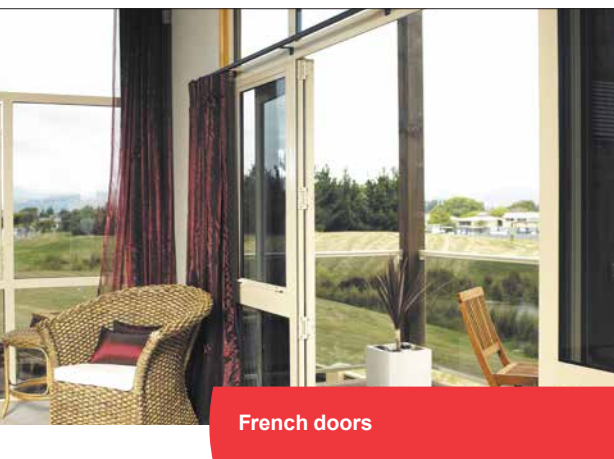

French and Hinged Doors

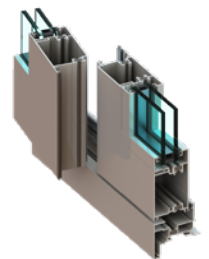

- French and Hinged Doors can be up to 2.7m high
- Panels can accommodate insulating glass units up to 30mm in thickness
- Optional flush sill feature for low trip hazard, a clean look and easy maintenance in high dust and debris areas
- Flush beaded appearance

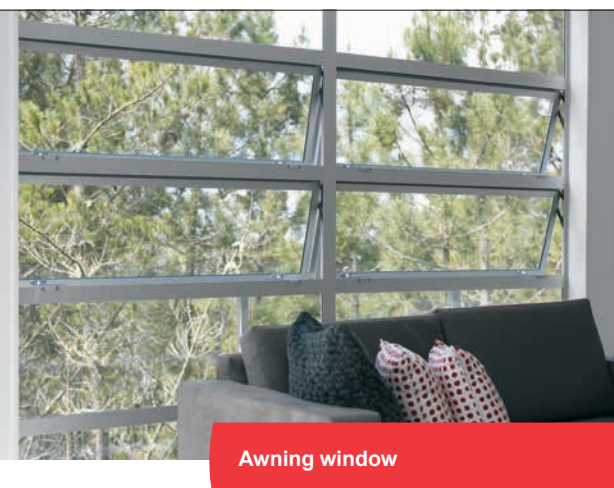

Awning and Casement Window

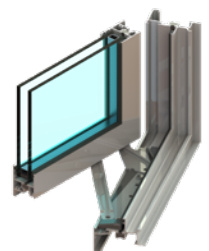

- Can accommodate insulating glass units up to 30mm in thickness
- Sashes: can accommodate insulating glass units up to 26mm in thickness
- Kleenline™ – Sash window frame platform cover, for a premium finished look that is easy to clean and maintain
- Flush-fit sash windows close inside the window frame offering a premium finished look



Pacific52™ Thermal

Next generation thermally broken aluminium joinery designed to deliver improved insulation, noise reduction, strength and a decrease in the amount of condensation forming on the surface of the glass. Our top performer.

Because we are in a transition period brought about by changes to section H1 of the New Zealand Building Code, the Pacific52™ Thermal System may not be available in some regions until 2023. Please discuss availability with your local Rylock consultant.

Pacific52™ Thermal

Pacific52™ Thermal represents the next step in aluminium joinery technology – an advanced union of form and function.

New Zealanders now enjoy the benefits of double glazing when renovating an existing dwelling or constructing a new home. Double glazing allows the sun's heat to pass through a window and be retained within the house thereby improving the comfort levels of the home.

Pacific52™ Thermal uses a 'Polyamide Strip' to extend the benefits of double glazing to the frames of your windows and doors. A thermal break within the frame is created by joining two pieces of aluminium together using a 16mm polyamide strip crimped to each side of the frame. The thermal barrier formed by the polyamide strip stops the transference of heat from the front of the frame to the back of the frame, thus stopping heat from passing into (or leaving) your house. As a result, your home is more comfortable and requires less energy to heat.

As you'd expect, sleek contemporary lines delineate the Pacific52™ Thermal System, while innovative features like the use of flat sill technology add aesthetic practicality allowing form and function to go hand in hand.

The Pacific52™ Thermal range can accommodate insulating glass units – double and triple glazed units – up to 40mm in thickness, while our Pacific60™ Thermal System, which is a range of extra strength fixed window panes designed for the most extreme conditions, can accommodate insulating glass units up to 48mm in thickness.

The Pacific52™ Thermal System can accommodate almost any combination of window and door configuration. Innovative products such as the iconic Ranchslider™, functional Levelstep™, premium Euroslider™ and the Foldback™ bifold are all available within the system.

HEIGHT



* Higher spans may be possible.
Please contact your local Rylock consultant for more information.



Euroslider™ door

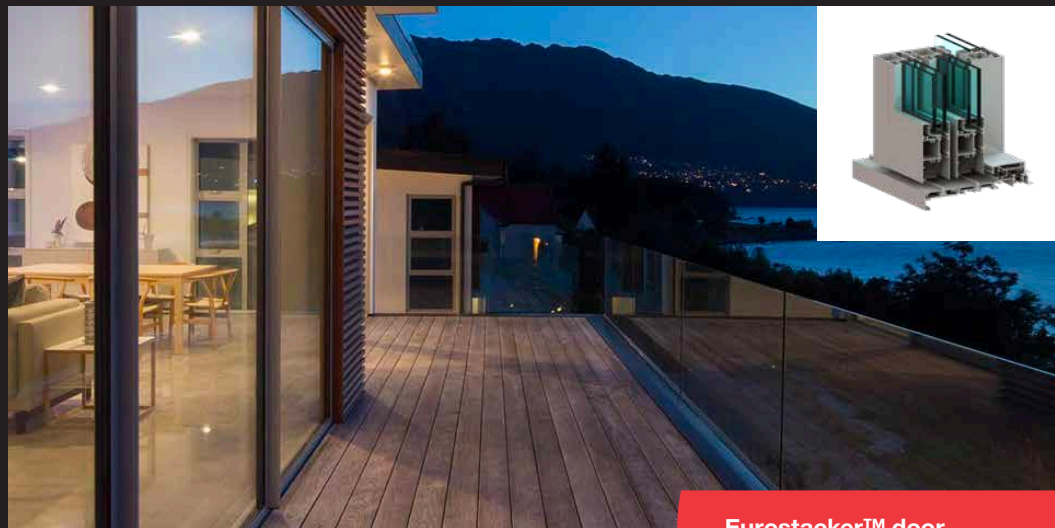

Eurostacker™ door



Features & Benefits:

- Can accommodate insulating glass units – double and triple glazed units – up to 40mm in thickness (48mm for Pacific60™ Thermal fixed pane windows)
- Performance expectation up to Extra High wind zones (2500pa ultimate wind pressure)
- Dual colour – ability to have different colours inside and outside
- Concealed drainage option – no visible drain holes anywhere
- High thermal performance and insulation
- Virtual elimination of condensation
- Reduced noise
- Sleek contemporary style

Pacific52™ Thermal Individual Product H1 Detail

The New Zealand Building Code requires windows and doors to meet specific energy efficiency performance levels known as R-values to achieve compliance. Required R-values vary by climate zone and can be achieved through an appropriate combination of glass (U-value), IGU elements (insulated glazing unit), spacer type and frame type. The table below sets out the minimum glass and IGU requirements for the Pacific52™ Thermal System based on the Schedule Method. Please use in conjunction with the Climate Zone map and Construction R-values table on pages 7 and 8.

Pacific52™, Pacific60™ Thermal Systems*	For Building Consents Submitted 03.11.22 - 30.04.23	For Building Consents Submitted 01.05.23 - 01.11.23	For Building Consents Submitted from 02.11.23
NZ Climate Zones 1 & 2	Minimum R-value 0.37		Minimum R-value 0.46
	Glass Minimum Requirements: U-value of 1.90 IGU: Low E1/Argon/Clear, Aluminium Spacer		Glass Minimum Requirements: U-value of 1.30 IGU: Low E3/Argon/Clear, Thermal Spacer
NZ Climate Zones 3 & 4	Minimum R-value 0.37	Minimum R-value 0.46	
	Glass Minimum Requirements: U-value of 1.90 IGU: Low E1/Argon/Clear, Aluminium Spacer	Glass Minimum Requirements: U-value of 1.30 IGU: Low E3/Argon/Clear, Thermal Spacer	
NZ Climate Zones 5 & 6	Minimum R-value 0.37	Minimum R-value 0.50	
	Glass Minimum Requirements: U-value of 1.90 IGU: Low E1/Argon/Clear, Aluminium Spacer	Glass Minimum Requirements: U-value of 1.10 IGU: Low E4/Argon/Clear, Thermal Spacer	

*Notes: (1) Demonstrating compliance with the Schedule Method should be done in conjunction with Table E1.1.1 as reproduced on page 9.
 (2) Table based on the Schedule Method by Climate Zone, R-value and U-value as set out in H1 Energy Efficiency - Acceptable Solution H1/AS1 Energy efficiency for all housing, and buildings up to 300m² (5th Edition, Amendment 1, 4 August 2022).
 (3) Table based on Schedule Method (30% glazed area) only. Information presented is not compliant under Calculation or Modelling methods.
 (4) Applicable dates based on consent submission, not construction dates.



Euroslider™ door

Sliding and Stacking Doors and Windows

- Doors can be up to 2.7m high with sliding panels weighing up to 200kg
- Minimum number of panels: Two panels – one fixed, one moving
- Maximum number of panels: As many as is practical, all sliding one way or bi-parting from the centre
- Euroslider™ and Eurostacker™ premium options available with flat sill feature designed for ease of cleaning in high dust and debris areas
- Classic kiwi Ranchslider™ and Ranchstacker™ styles are available with optional Levelstep™ Sills for a true flush threshold
- Door concealment options such as Overwall, Cavity and Corner sliders are available along with Biparting and Corner Biparting options
- Performance beyond Very High wind zone rating

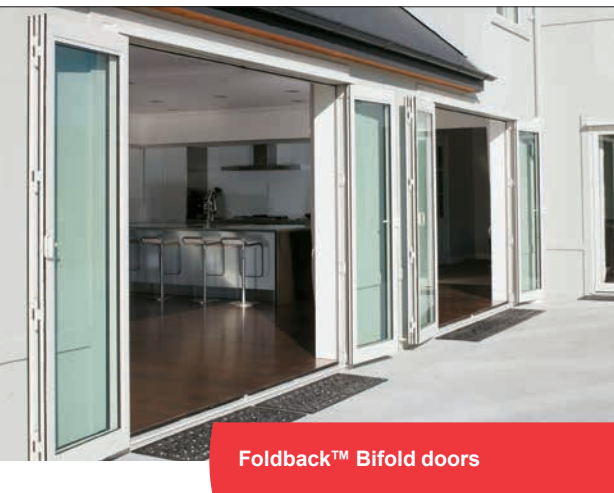
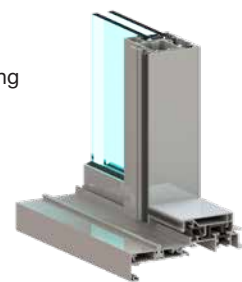

Foldback™ Bifold doors

Bifold, Foldback™ Bifold Doors and Windows

- Bifold and Foldback™ bifold panels can be up to 2.3m high with Bifold panels weighing up to 80kg; Foldback™ bifold panels up to 50kg
- The patented Foldback™ Head allows the panels to fold 180° and lay flat against the clad wall to create even more outdoor space
- Top Hung doors protect the rolling gear from dust and harm, allowing for a flush sill to be inserted at the bottom of the unit ensuring easy maintenance and a clean look
- Bottom Rolling doors have the rolling mechanism at the bottom of the panel making them better suited for larger spans across wide openings

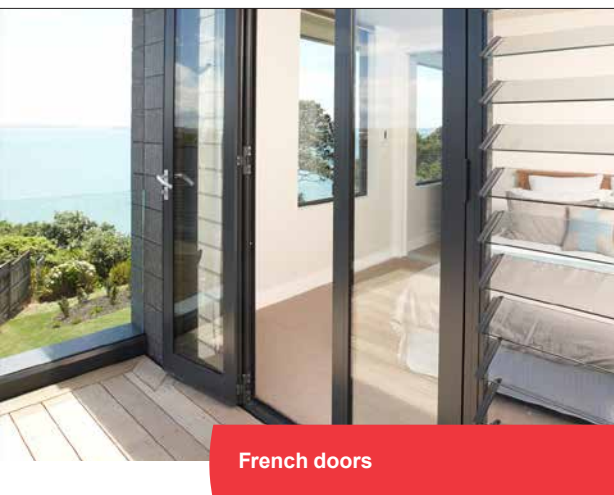

French doors

French and Hinged Doors

- French and Hinged Doors can be up to 2.4m high x 1m wide, rigidly braced with a unique built-in glass blocking system
- Optional flush sill feature for low trip hazard, a clean look and easy maintenance in high dust and debris areas

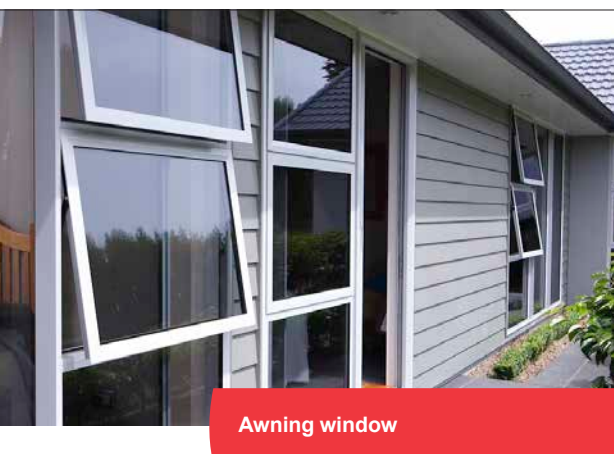
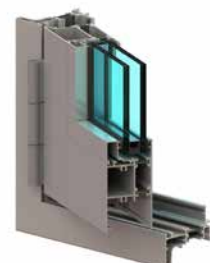

Awning window

Awning and Casement Windows

- Box back mullion options
- 24mm polyamide thermal strip available for windows to further enhance thermal performance of the frame and accommodate larger triple glazed units
- Kleenline™ – Sash window frame platform cover, for a premium finished look that is easy to clean and maintain
- Flush-fit sash windows close inside the window frame offering a premium finished look

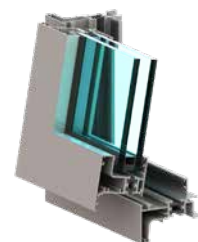



Baltic™ Commercial System

The **Baltic™ Commercial** range of joinery is bold and robust, designed with the visual aesthetic in mind. The modern, visual effect of a flush vertical structure is not only impactful, but also highly adaptable and suitable for a wide range of applications, including residential.

The **BALTIC™** commercial range caters for today's changing environmental conditions, providing solutions for heating and lighting concerns via a selection of high-performance glass options, and ventilation issues with the addition of awning or casement windows.

Our commercial range consists of three systems: Shop Front, Flush Glaze and Bespoke Curtain Wall, all complimented by a selection of robust 48mm commercial doors.

Baltic™ Commercial Systems Benefits:

- Greater spans achievable before a larger base size is required
- Structurally glazed options are available
- Multiple story glass walls achievable
- Seamless integration with the Atlantic48™ System



Shop Front and **Commercial** Doors



The **Shop Front System** is ideally suited for ground floor applications, shopping malls, car showrooms, supermarkets, banks and retail outlets.

The Shop Front System can be incorporated into your project internally and externally. Internally, the system is ideal for use as partitioning or for creating wind lobbies in situations where uncontrolled ventilation or airflow may be an issue.

The 75mm and 106mm options provide flexibility to suit various applications. Designed with weathering in mind, each pane of glass is individually drained to the outside to ensure the integrity of the system and prevent the ingress of rainwater.

The Shop Front System is compatible with the 106mm Flush Glaze and Bespoke Curtain Wall Systems, as well as the architectural window and door range of products. It also integrates seamlessly with Atlantic48™ meaning it can be used on large scale residential projects. The System is truly versatile – it can accommodate any combination of hinged, pivoting, sliding, bifolding or automatic doors.

The Shop Front System includes a variety of heavy-duty commercial doors designed and built for security, strength, and endurance. Your local Rylock consultant will be happy to walk you through the entire range which can be manufactured to any practical size requirements and specifications.

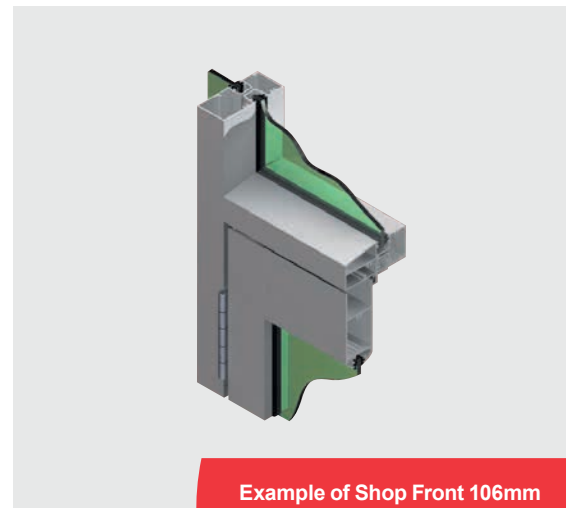

Example of Shop Front 106mm with commercial door



Flush Glaze



The **Flush Glaze** System is a highly versatile product that can be used in a variety of situations, from a single-storey office or factory complex through to multi storey, high rise apartments or office towers in exposed locations.

The benefits of using the Flush Glaze System lie in the variety of appearances that can be achieved by utilising the many glazing options. Flush Glaze is a unitised curtain wall system specifically designed with flexibility in mind, allowing mullions and transoms to be concealed or exposed in any combination. Whatever you choose, single glazing, reflective glass and double glazing options are possible.

It is ideal for large glazed spans in all commercial applications including multi-storey. It integrates seamlessly with Shop Front (106) and our commercial door range to ensure flawless aesthetic results. It also integrates perfectly with Atlantic48™, blurring the boundaries between commercial and residential architecture.

The Flush Glaze System is available in three depth options: 106mm, 136mm and 159mm sizes. The 106mm system is ideal for low rise buildings where spans and wind loads are not a limiting factor. At the other end of the spectrum is the 159mm system which is capable of spanning greater distances between fixing points and will tolerate very high wind loads such as those found on high rise buildings.

Captive or structurally glazed options are available in either 2-sided or 4-sided configurations. The system can accommodate single or double glazed units up to 33mm in thickness with bespoke design and testing available upon request.



Example of structurally glazed mullions with captive transoms



Bespoke Curtain Wall



Bespoke Curtain Wall designs are commonplace for commercial façades. For buildings that require out-of-the-box thinking and specific design solutions, Rylock (along with partner Altus Window Systems) can assist in realising large scale visions.

Whether that involves designing glazing to span two or more floors of a façade to create the impression of a continuous wall of glass, finding a solution to reduce noise levels or overcladding an existing building to update its appearance, we're more than happy to work on bespoke designs that meet your project specifications.

The Bespoke Curtain Wall System offers a choice of stickform and unitised methods of manufacture and installation. Each system is unique and offers the building designer flexibility in terms of design and appearance while also providing integrated solutions for issues such as thermal efficiency, ventilation and the provision of natural light.

Decorative features can be added to the Bespoke Curtain Wall System to enhance appearance and performance. Other features include clip on beads, sun louvres and box sections.

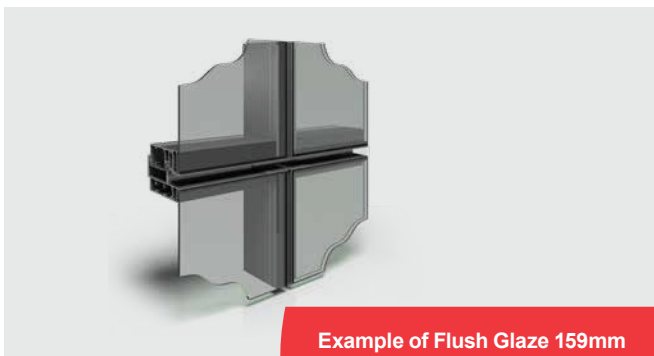

Example of Flush Glaze 159mm in high rise application

Flush Glaze

The Flush Glaze System can be augmented to suit the specifications of your particular project.

A1 Curtain Wall 150mm

The A1 Curtain Wall is a flexible, innovative, high performance, weathertight and cost effective unitised curtain wall system designed to meet the demanding architectural requirements of today's state of the art contemporary design building façades. The A1 has an optional clip on half round bead which can be surface finished to express the horizontal lines.

Bespoke Curtain Wall 160mm

The 160mm traditional stickform Bespoke Curtain Wall System has mullions that can be structurally glazed or express glazed with the option of incorporating other features such as aluminium cladding or granite inserts.

One standout feature of the 160mm Bespoke Curtain Wall is the incredible range of creative ideas it can be applied to. For example, the Bespoke Curtain Wall's ability to incorporate elliptical faceting and faceting of tight radii has been used to create a curved vertical façade, which to the casual observer, appears to be a beautiful wave.

Other Systems & Products



Alti™ sliders

Alti™

Composite Aluminium and Timber Joinery

The ALTI™ composite system combines aluminium and timber into one window and door system. On the exterior, it utilises the proven performance of aluminium joinery and design, and on the interior, it exploits the thermal performance and character appeal of timber.

As a product, wood satisfies the senses – it is soft and warm to the touch while possessing a natural appearance. ALTI™ draws from the natural characteristics of timber: beauty, craftsmanship, quality and permanence, and combines these with the practicality and low maintenance benefits of aluminium.

ALTI™ is only available from a limited selection of Fabricators. Please visit the ALTI™ page to learn more:



Louvres: natural ventilation

Louvre Windows

Breezeway Louvre windows are designed to bring light, air and space into a building. Opened, louvres connect you to the outdoors while letting light and fresh air into your home, improving indoor air quality and helping to keep you comfortable without artificial heating or cooling systems. When you want to keep the weather out, closed Breezeway Louvre Windows provide the tightest Award-winning and cyclone rated – Breezeway Louvre Windows are an energy efficient window option for your next project.

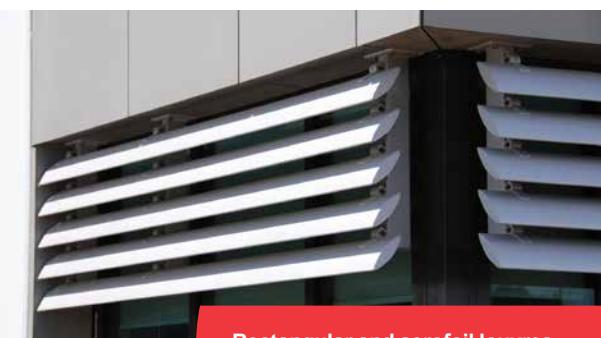

Rectangular and aerofoil louvres

HighbrookLouvre™

The clean lines and surface finishing of the HighbrookLouvre™ are designed to enhance the appearance of commercial building facades while providing a range of useful and functional benefits. For example, as sunshades, the HighbrookLouvre™ can contribute to the energy efficiency of a building. The louvres blend seamlessly into the surrounding joinery and complement the overall building design. The HighbrookLouvre™ System is available in multiple rectangular and aerofoil configuration options and utilises an innovative mounting arrangement to achieve the desired look.

HighbrookLouvres™ can be used in residential projects but are most often used in multi-level buildings and apartments for privacy and design reasons. HighbrookLouvre™ can be custom designed and configured to suit a project or façade. Also, there is flexibility with fixing options and brackets used to mount the louvres.



Raked windows

Specialty Windows

Aluminium joinery offers such a wide choice of colour and design possibilities, even the simplest construction project can be transformed into a stunning architectural statement. Your imagination is the only limit.

A feature window such as a Box, Bay or Raked Window or Skylight will add character inside and out plus bring additional light and ventilation into the room.

Types of Specialty window available:

- Bay, Greenhouse, Skylight, Raked, Double hung



Let in the light

Millennium Roof Windows

A great way to bring light and ventilation into your home.

Maximum sizes for roof windows and sashes vary by width, height, wind zone and glazing requirements. Your local Rylock consultant will be able to advise you on a suitable configuration for your project.

As a guide, fixed window panels up to 1500mm high by 1000mm in width are attainable, however, you should be aware that constraints within the New Zealand Building Code may restrict the maximum size permissible.



Bring the outdoors inside

Conservatories

Conservatories are a great way to add an extra room to your home. Whether it be a cosy retreat in the winter or a cool haven in the summer, your conservatory can add a whole new dimension to how you live in your home.

Ask your local Rylock consultant about the design combinations available and the window and door options you can include to make your conservatory an individual statement.

Features:

- More living space, plenty of light, cosy and relaxing with a connection to the outdoors

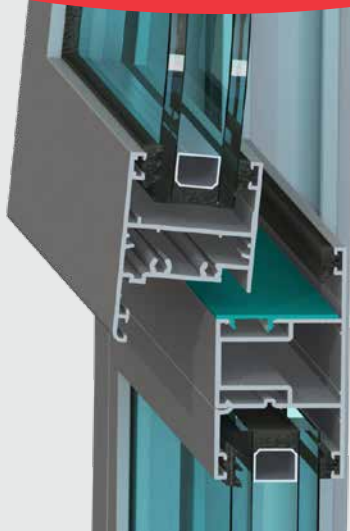

Kleenline™ –Sash window frame platform cover

Kleenline™ platform cover

Kleenline™ platform covers are simple and elegant in their conception and execution. They are beautifully machined aluminium covers that can be inserted into all four sides of a sash window frame or just the sill. It can also be used in conjunction with sliding doors. The purpose of the Kleenline™ infill is to cover the exposed openings and cavities present in all window frames and sliding doors to create a smooth flat finish.

The outcome is visually clean and modern as well as super functional. Besides providing a flat surface that is easy to clean and maintain, Kleenline™ stops the buildup of unsightly dirt and debris. This in turn prevents the likelihood of bugs and other creepy crawlies setting up home in your joinery.

Kleenline™ platform covers are compatible with all Rylock joinery systems.

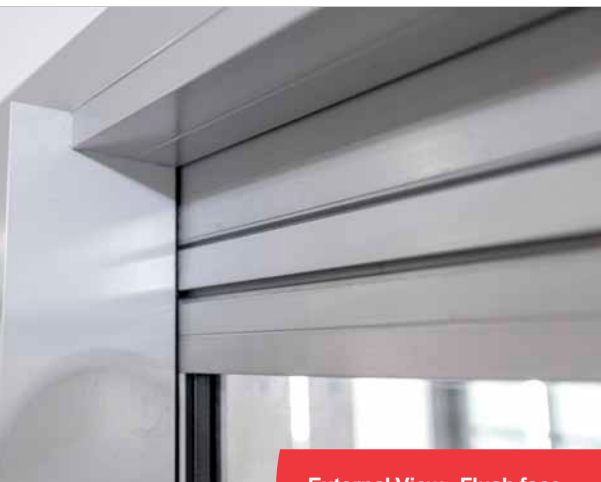

External View - Flush face

Aluvent™ Passive Ventilation

Passive ventilation is an important factor in minimizing energy use in buildings. Ventilation is also a crucial consideration for any building as good ventilation ensures that air circulates, even when windows and exterior doors are closed, keeping the environment fresh and healthy.

For maximum effective performance there needs to be a cross flow of air. Aluvent™ is a passive ventilation system that allows air to flow freely from the inside to the outside of the building through a secure screened aperture that can be easily opened or closed. This flow of air reduces condensation and helps to achieve the minimum air exchange requirement set out in the building code.

Aluvent™ can be installed in most windows and doors although there are some limits on the configuration options, so please speak to your local Rylock consultant for more details.

Aluvent™ provides:

- Controlled airflow into a building via a ventilation slide
- A secure and weather protected way of providing ventilation when occupants are away from the premises making it ideal for beach houses and wet areas like ensuites, bathrooms and laundries
- Vents that are fully adjustable from the inside, with a built-in insect proof mesh



Internal View



Before



After

Retrofit, Insert and Replacement Windows and Doors

What does it mean to go from single glazing to double?

Simply put, it means replacing the old single glazed glass in your home with new double glazed glass.

The current make-up of your windows and doors, that is for example, what material your windows are made of (aluminium or timber) and the level of wear and tear, will determine which specific type of service you require.

When looking to upgrade your glazing there are a few options to consider. You could:

- Replace the glass only
- Replace the glass and opening panels
- Replace the glass, opening panels and frames
- Or, if completing a renovation, you could consider changing the type of opening, say replace an existing window with a door

For example:

If you have aluminium joinery

And it is in good working order... a retrofit glass replacement would be appropriate. This is the least complex process. The existing single glazed window and door panes are removed and replaced with new double glazed window and door panes. Rubber seals, aluminium clip beads, window stays and handles all replaced.

But if the aluminium frames are compromised, damaged, or are not up to the carrying the added weight of new double glazed glass... a full replacement of the window and door frames would be appropriate. The frames along with the actual windows and doors would be replaced with new aluminium ones.

If you have timber joinery

And it is in good working order... a timber insert frame retrofit would be appropriate. This involves removing and recycling your existing timber windows and doors and replacing them with new aluminium double glazed windows and doors which we insert discreetly into the existing timber frame.

But if you think your existing timber joinery is in such a state that a full replacement is your only option, you should be aware before starting any work that a builder and subsequent trades may be required to complete the job to a finished standard, especially if you are concerned about the timber frames being compromised, damaged, or not up to carrying the added weight of new double glazed glass.

Your local Rylock consultant will be happy to discuss all aspects of your particular project and help you work towards finding the most appropriate solution.

Stellar Doors™

Because First Impressions Count

Strong, Secure and Durable Doors

The Stellar Doors™ Entrance range creates a warm welcome for your home that will really last. That's because Stellar Doors™ are made from aluminium. They're stronger than timber. They won't split, warp or leak, so there's little maintenance required. In fact, Stellar Doors™ are designed to last. And because they're structurally stronger than conventional doors, Stellar Doors™ provide you with more security.



SR15 The No.1 seller

Thermally Broken Doors

Combining Stellar Doors™ with a thermal break and poly fill can provide greater insulation for your home as illustrated by the table below which shows the percentage increases in R-value compared to a standard aluminium door in a typical New Zealand environment.

DOOR TYPE	% increase in thermal benefits over standard door (R-value)
SR11	-
SR11 – Non-thermal break with Poly Fill	11%
SR11 – Thermal break with Poly Fill	39%

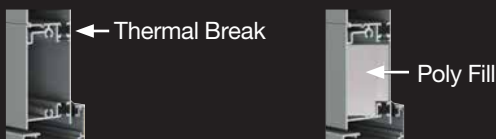

Please note: Poly Fill is standard on all SR11 doors. Benefits of Poly Fill include noise and condensation reduction as well as a small thermal effect.

Lasting Elegance

The powder coat finish gives you a door that lasts, in the style you want. Whether you're after a traditional look, or perhaps something more contemporary, we have a door to suit. The range of finishes also includes a wood grain that gives you all the warmth and beauty of timber with the durability of aluminium, all with a 15 year warranty.

Create The Look You Want

With Stellar Doors™, you can create an entrance that is unique. Configurations include single and double door combinations. Why not add sidelights or overlights to increase the visual impact and add a sense of luxury, light and space. All of our doors are available in a range of standard sizes. Or, if you are after something a little different, we can custom make your door or doors to fit with your plans. Shown here are just some of the styles you can choose from.

Door Selections

Standard Aluminium Entrance Door Configurations

Traditional



SR1 SR2 SR8 SR3

Modern



SR13 SR14



SR4 SR5 SR6 SR7



SR15 SR16

Tongue & Groove - Frameless



SR11 SR19 SR20

Tongue & Groove - Framed



SR9 SR10 SR12

Options are only limited by your imagination – each of these can be configured in multiple ways. Discuss your preferred option with your local Rylock consultant.



SR2 Traditional Door with glass



SR11 with Overlight and Sidelight

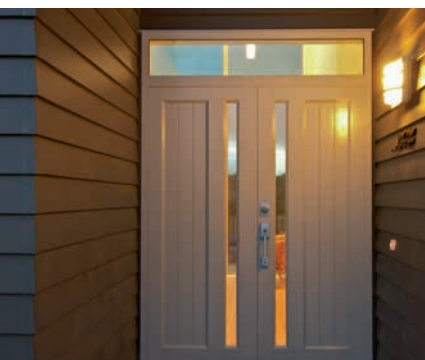

SR10 Double Doors with Overlight



SR6 Traditional Door

Single Doors

Single entrance doors are common in many homes. They provide an enticing approach when coupled together with pathways leading directly to the entrance way. Single doors can be accompanied by sidelights or overlights to make the entrance way more inviting as well as provide a sense of drama and space.

Sidelight and Overlight Panels

Matching fixed sidelights are available to suit all standard doors or can be made to suit custom doors. Overlights help to increase the visual impact of an entrance way, adding a feeling of luxury, light and space.

Double Doors

Double doors help create a feeling of grandeur by visually adding greater dimension and substance to a building. Coupled with sidelights and overlights, a Stellar Doors™ double door can assist you in creating an impressive entrance way for your home.

Finishes

Stellar Doors™ are available in any powder coat colour; below are the most popular bright finishes and wood grain options. See pages 47-49 for a full range of colours.

Bright Finish Options



Wood Grain Finish



Top tip

Upgrade your Stellar Door with a digital lock. Adding one will make your home and the people in it feel more secure.

Please see page 46 for more options and information.

Yale 3109A Digital Door Lock



Strong



Secure



Durable

Stellar
DOORS

Proudly
NZ Made

Electronic Digital Door Locks



Pairing your Stellar Door with an electronic digital lock means you never need to worry about carrying around, or losing, keys again. Lock and unlock your home with ease using a simple keypad touchscreen or proximity card.

We can tailor our Stellar Doors™ to any digital lock but here are some of the most popular units and hardware that we work with.

Pair your digital lock with Malta™ hardware.



Malta Hinged door handle

Malta Long pull handle



Yale 7220 Digital Door Lock

COMING SOON

Combining high security with cutting edge technology, the Yale 7220 is a high quality security solution for the contemporary home.

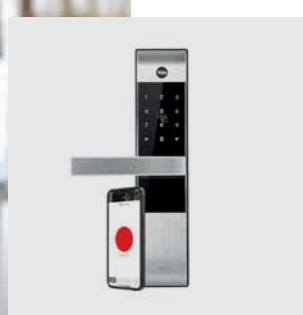

Yale 3109A Digital Door Lock

Can be opened with PIN code, proximity card or traditional key... peace of mind never looked so good.

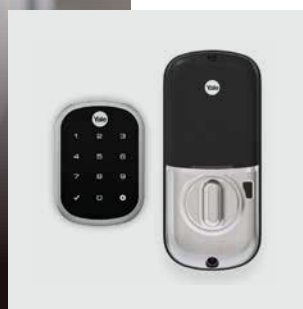

Yale ASSURE Lock™ SL Deadbolt

Don't be fooled by its discreet slimline appearance – this is a robust and tamper proof deadbolt.



Schlage Ease™ S2 Smart Entry Lock

The Schlage Ease™ range is simple to install and easy to programme, storing up to 20 access codes. Pair your lock with the Schlage Abode app on your smartphone, for effortless access and control of your lock. Go keyless, for a smarter way of living.



Windsor Smart Entry Set PhoenixL1

With five different locking options including Wi-Fi and Bluetooth, you'll never need to scramble for your keys again. Multiple user pin-codes (including temporary codes) can be programmed and easily sent via text message. Card access and a backup mechanical keyway are also available for peace of mind.

Colour options

We offer a choice of either anodising or powder coating. Please speak to your local Rylock consultant to find the right solution for you.

Anoguard™ Anodising

Adding super strength to the colour finish of your windows and doors

Whenever aluminium is exposed to the air its surface naturally begins to oxidise and form a defensive layer which shields and protects the metal underneath from deteriorating.

Anodising is an electrolytic process that enhances this natural process to produce an even thicker protective layer, resulting in a finish that is durable and highly corrosion resistant. This process differs from powder coating in that anodising is a thickening of the base metal itself, as opposed to adding a coating, like paint. This is why an anodised surface will not chip or peel – the colour is part of the metal and therefore offers enhanced protection against sunlight, corrosion, heat and moisture.

The thickness of the anodic layer

affects the metals anti-corrosion performance and longevity – the thicker the oxide layer, the better the corrosion resistance.

Key facts

- Anodising is one of the most durable joinery finishes available
- Aluminium joinery with an anodised finish comes in a range of colours, from natural (silver) through to bronzes and black
- Anodising delivers a translucent finish which may show the grain of the base metal and can exhibit die and flow lines. Whilst all care is taken to produce a consistent colour and finish, variations will always exist. Please speak to a Fisher Windows consultant about your colour and

finish expectations before making a final decision

- With regular maintenance, anodised aluminium can stay looking as new for the life of the joinery

Benefits

- Durable and weather-resistant – perfect for coastal locations
- Extremely hard and will not flake or chip off
- Has an even film thickness, even around sharp edges
- Deep metallic appearance as the finish is translucent revealing the base metal beneath – ideal for architectural applications
- Excellent UV resistance

Colours

The process of Matt Etching smooths out surface imperfections in the metal prior to anodising. It also delivers a matt finish as opposed to a bright one. All of our colour options employ Matt Etch anodising.

Matt Etch comes in a range of colour finishes:



Natural

- 12 Micron (454)
- 20 Micron (455)
- 25 Micron (456)



Light Bronze

- 12 Micron (457)
- 20 Micron (458)
- 25 Micron (459)



Medium Bronze

- 12 Micron (460)
- 20 Micron (461)
- 25 Micron (462)



Dark Bronze

- 20 Micron (468)
- 25 Micron (469)



Black

- 20 Micron (470)
- 25 Micron (471)

Colours are indicative only.

ColourScape™

The perfect finish for your windows and doors

Colour Collection

The ColourScape™ range is a quality decorative selection of surface finishes for aluminium windows and doors.

There are no less than 36 powder coated options in our popular ColourScape™ range, plus over 100 more to choose from in matt, gloss, satin, flat, pearlescent and textured finishes. It means that whatever look you're after, our range of colours can easily complement any of your existing colours of cladding, roof and gutters.

As well as providing great colours for your windows and doors, ColourScape™ is designed to protect your aluminium joinery and retain the colour integrity for at least 15 years.* That's down to a high UV tolerance, designed to withstand the harsh New Zealand climate.

Why not colour co-ordinate?

Consider enhancing your colour selection with colour co-ordinated hardware. We can help you create continuity and style with a range of options available for most colours.

In association with:



Please ask your local Rylock consultant for further details.

† Denotes Malta and Aria Hardware Co-ordinates

^ Denotes Coloursteel Co-ordinates



Duralloy® +Plus Contemporary

The Altus Contemporary Collection spans the colour spectrum from subtle neutral tones that blend naturally with New Zealand's environment, to bold dramatic colours that express individuality – perfect for city style. The range caters to traditional homes as easily as it caters to modern trends in building design.

Duralloy® Plus Urban Collection

These colours are a selection of the latest innovations in powder coating finishes. Created to complement new architectural trends, these shades add a new aesthetic dimension to aluminium joinery with their pearlescent finishes.

Protecture™

A highly mar and scuff resistant fine textured finish designed to protect. The advanced highly durable powder technology significantly reduces the visible mar and scuffing that happens day-to-day.

Available in a range of popular colours. Ask your local Rylock consultant for a list of available options.

Duratec® Intensity® Brights Range

A collection of bold, bright solid colours that produce a vibrant impact, delivered with super durable powder coating technology. Ideal for entrance doors or situations where long term optimal architectural aesthetic performance is required.

Warranty

The colours in the ColourScape™ colour card are warranted through the provision of Dulux® Alumi Shield™ warranties for its Duralloy®+Plus™, Protecture™ and Duratec® Intensity® powder coating products on recommended projects, and subject to specified warranty terms and conditions.



Warranties are made up of a colour warranty (for colour fade and chalking) and a durability warranty (film integrity for aluminium only). They are only valid when applied by a Dulux Accredited Powder Coater according to the warranty specifications on architectural aluminium, on approved project types and conditions.

*For more information visit duluxpowders.co.nz/warranties

NZ's Top 6 Trending Colours

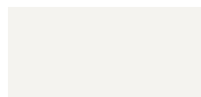

Appliance White Matt †
901
20S1364M LRV: 89



Metro Silver Pearl Kinetic Satin †
928
21P7831S LRV: 46



Grey Friars Matt †^
906
20S7809M LRV: 10



Ironsand Matt †^
902
20S8383M LRV: 7



Flax Pod Matt †^
903
20S9218M LRV: 6



Black Matt †^
900
20S9041M LRV: 4

NZ's Popular Colours

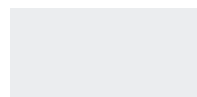

Arctic White Satin †
901
20S1358S LRV: 82

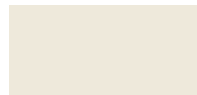

Off White Matt †
912
20S3240M LRV: 77



Canvas Cloth Matt †
917
20S7830M LRV: 63



Desert Sand Matt †
920
20S3239M LRV: 45



Permanent Green Matt †
922
20S6450M LRV: 10



Scoria Matt †
924
20S4382M LRV: 9

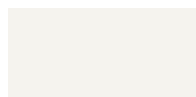

Warm White Pearl Kinetic Matt †
931
21P1367M LRV: 89

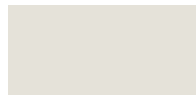

Bronco Matt †^
923
20S2253M LRV: 38



Bond Rivergum Matt †
925
20S6448M LRV: 19



Karaka Matt †^
914
20S6446M LRV: 7



Anotec Mid Bronze Matt †
910
20S8385M LRV: 6



Pure White Gloss †
911
20S1365G LRV: 85



Gull Grey Matt †^
915
20S7828M LRV: 49



Lichen Matt †
921
20S6449M LRV: 26



Thunder Grey Matt †^
919
20S7825M LRV: 12



Window Bronze Kinetic Matt †
934
21P8394M LRV: 9



Metro Electric Cow Kinetic Matt †
932
21P8395M LRV: 9



Ghost Grey Matt †
913
20S7829M LRV: 44



Sandstone Grey Matt †^
908
20S7807M LRV: 25



Gunmetal Metallic Kinetic Matt †
933
21P8391M LRV: 14



Lignite Matt †
916
20S8393M LRV: 9



Windsor Grey Matt †^
918
20S7823M LRV: 7



Metro Coal Dust Kinetic Matt †
930
21P9221M LRV: 6



Silver Star Kinetic Satin †
929
21P7820S LRV: 35



New Denim Blue Matt †^
909
20S5392M LRV: 11



Slate Blue Matt †
927
20S5403M LRV: 8



Charcoal Matt †
907
20S9219M LRV: 8



Gravel Matt †
926
20S7824M LRV: 6



Protecture Black Flat
935
20T9215F LRV: 4

NZ's Favourite Bright Colours



Intensity Moonlight Satin
937
90N2004S LRV: 63



Intensity Sunshine Gloss
941
90N2084G LRV: 48



Intensity Tomcat Gloss †
939
90N4383G LRV: 21



Intensity Flame Gloss †
938
90N4007G LRV: 13



Intensity Leaf Satin
936
90N6167S LRV: 24



Intensity Reef Gloss
940
90N5011G LRV: 19

Colours are indicative only. If you cannot find the colour you are looking for please speak to your local Rylock consultant. Colours may carry a price premium.

Colour Selection Guide

Choosing the colour and surface finish for your windows and doors is a crucial part of the design process for your home. It is important that you choose the right product for the right application to ensure the life of your surface finish, and in some cases that your windows and doors are covered under their warranty. Our simple step-by-step guide will help you through this process.

Step 1

Choose the right product:

- Consider your environment and site conditions, especially if your home is coastal. Your site location will determine the performance requirements of the surface finish.

Step 2

Choose the right colour

- There are a number of options to choose from. A good place to start is the top 6 trending colours.
- If you want a colour that is not in the popular range, discuss this with your Fabricator.

Step 3

Speak to your local Rylock consultant:

- Consult with your local Fabricator for further advice and to request an individual colour swatch.
- A word to the wise: when you are making your final colour selection, assess your colour swatch in natural light.



Glass selection

Window Glazing Types

The term glazing refers to the layers of glass that are sealed in a frame to make up a window. Traditionally, single glazing, with just one pane of glass in the frame, was used. Today, double glazing – using two layers of glass – is standard for new houses as having two panes of glass significantly reduces the amount of heat lost through the window, thus increasing the energy efficiency of the home. In environments where extreme weather is commonplace, triple glazing can be used.

How double and triple glazing works

Glass is a good conductor of heat, which is why heat can travel or transfer straight through a single pane of glass virtually unhindered. Air on the other hand, is not a good conductor of heat which is why it is used in double and triple glazing. Double or triple glazing is where two or more panes of glass are spaced apart and then pneumatically sealed with air or gas trapped in the cavity between them. The air in the gap – air, remember, is a bad conductor – insulates your home by stopping the transfer of heat between the panes of glass.

Heat loss can be further reduced by coating one or more panes within the double glazed unit with a transparent **Low Emissivity (Low E) coating**, which reflects heat back into the house. There are a range of Low E options – speak to your local Rylock consultant about which option is best for your particular project and budget.

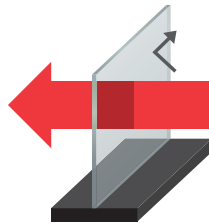

The best results are achieved by teaming double or triple glazing with thermally efficient window frames. Double or triple glazing units can also accommodate a wide variety of treatments in order to meet your requirements for safety, security, fire resistance, acoustic performance, UV reduction or even just to match your decor.

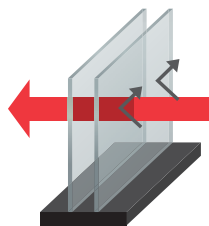

Single glazing

A single pane of glass provides very poor insulation because glass is a good conductor of heat. Much of the heat in your room would literally go out the window.

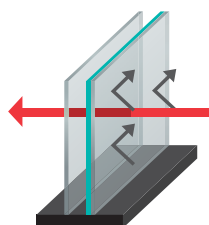

Double and triple glazing

Double or triple glazing traps a layer of air between two or three panes of glass. Because air is a poor conductor of heat, much less heat is lost through the window. And, if the inside of one pane has a Low E coating, even less heat is lost, because the coating reflects heat back into the room.

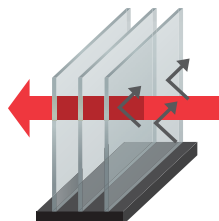

Double glazing is now standard for all new houses - why?

- Reduces the amount of condensation forming on the surface of the glass
- Keeps your house warm in winter, cool in summer
- Reduces energy bills
- Reduces noise
- Requires minimal maintenance
- Improves security
- Upgrades and adds value to your home

In double glazing, the air between the two panes of glass acts like an insulating 'blanket', helping you control the temperature of your home. As the name suggests, triple glazing has three panes of glass, adding an extra insulating layer for additional warmth. It is most often used in areas with colder climates, such as the South Island. For new builds, double glazing paired with the appropriate glass and IGU (insulated glazing unit) elements are needed to meet the minimum energy efficiency requirements specified by The New Zealand Building Code.

The thermal break - a closer look

Thermally broken joinery extends the benefits of double glazing to the frames of our windows and doors. But what does this mean and how does 'thermally broken' joinery actually work?

The Southern41™ thermal break is made using the Pour and Debridge method while the Pacific52™ Thermal System employs a Polyamide Strip – both represented by the green strip in the diagram below – to create a thermal break within the aluminium frame.

Aluminium is a good conductor of heat in its own right, and this break stops heat, cold and noise from transferring through the metal frame and into your house thereby providing a further layer of protection and insulation. As a result, your home is more comfortable and requires less energy to heat in the winter or cool in the summer.

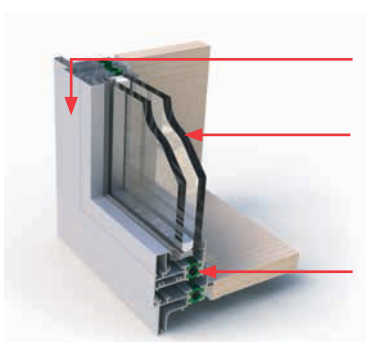

Window Frame

Double Glazing

Excellent thermal and acoustic insulation

Thermal Break

Effective barrier preventing transmission of heat, cold and noise



Key facts

- Single, double or triple glazing refers to the number of panes of glass that are sealed in a frame to make up a window
- Double or triple glazing has a layer of insulating air, or other gas, between panes that acts in a similar way to a fibreglass batt in a wall. It reduces heat loss from windows and increases comfort and warmth
- Other benefits of using double or triple glazing can include lower energy bills and reduced noise
- A Low E glass coating can further boost the benefits of double or triple glazing
- Thermal performance indicators measure the effectiveness of glazing and help to illustrate the improvement that double and triple glazing can make to the energy efficiency of your home

Malta™ Hardware

A Touch Of Architectural Elegance

Give your windows and doors the exact look you're after with the Malta hardware range. Specifically designed to match the Window and Door System of your choice, Malta is a style to please every taste – from elegantly discreet to distinctly architectural – with every piece built to last.

FINISHES

• Powder coated • Stainless steel • Satin chrome



Low profile



High profile

Venting

Malta™ Window Fasteners

These simple yet solid window fasteners are available in a number of styles, including low profile, high profile and double tongue venting. Low profile fasteners are ideal if you have a sliding door that slides to the inside of a window sash, whereas high profile fasteners are the more ergonomic choice and allow more finger room. Completing the range is the double tongue venting fastener, whose unique double tongue set up enables controlled ventilation with one simple action.



Two point bifold lock



Bifold hinge and handle set

Malta™ Bifold Handle Sets

The Malta™ bifold handle set incorporates an elegant, low-profile handle designed to operate a two-point bifold lock.

This set can be used in place of two flush bolts to provide a single point of operation. For additional security, an internal locking option is available, which can be fitted 'in-stile' or morticed.

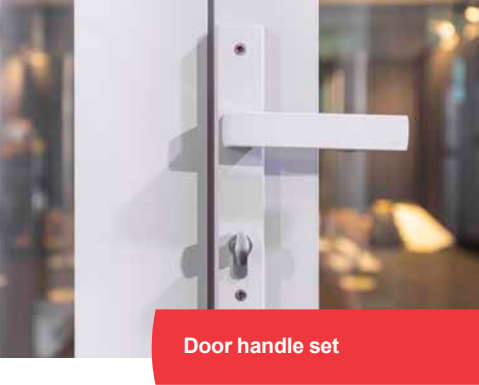

Door handle set

Malta™ Hinged Door Handle Sets

These elegant door handle sets are available in a range of options, all designed specifically to complement your preferred Windows and Doors system.

Locking options include two and four-point mortice locks with 30mm or 40mm backsets, coupled with five-pin Euro profile half and full cylinders. Both options are available with or without turn knobs.



Short & long flush pull

Malta™ Sliding Door Flush Pulls

Available in two different sizes (140mm and 250mm), these flush pulls are a simple, unobtrusive solution for sliding windows and doors. They sit just 3mm above the surface of the joinery, which together with their sleek, low-profile design makes for a modern and stylish look.

Malta™ flush pull kits are supplied with a morticed sliding door lock and include a removable Malta™ styled turn knob, providing an alternative, more convenient locking option.



Short D pull handle with morticed lock

Malta™ Sliding Door D Handles

The Malta™ D handles are a nonintrusive, stylish option for large or small sliding doors. As with the Malta flush pulls, these handles are supplied with a single point mortice lock.

You can choose from either 200mm or 400mm size options depending on the door's dimensions and your design preference.



Large D pull handle with snib latch

Malta™ Entrance Door Sets

As the focal point for most homes, the entrance door demands more decorative hardware. The Malta™ entrance door sets are available in a brushed nickel finish and are sure to make a good first impression.

Our large Malta™ D handle is matched with large 50mm backset mortice locks, available in both two and fourpoint lock options for increased security and weather performance.

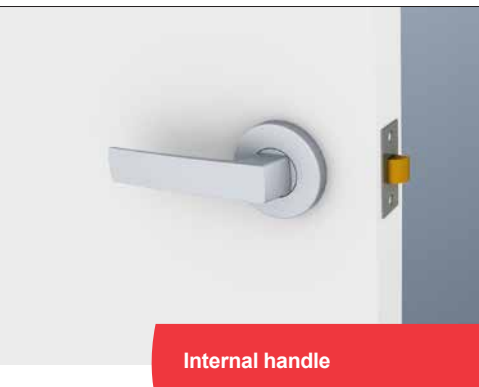

Internal handle

Malta™ Internal Furniture

The Malta™ internal furniture range perfectly complements any Malta™ hardware used on the perimeter of a home. It is available in satin chrome and thanks to its innovative design, sets a benchmark in ease of installation. The range includes passage sets for connecting doors, privacy sets for bathroom and toilet doors, and dummy half sets for use on cupboard and wardrobe doors.

Lucerne Window and Door Hardware

Within the premium **Lucerne Architectural Hardware Series** you'll find a style to perfectly complement the unique design of your windows and doors.



Large D pull handle with morticed lock



Low profile sash handle

Lucerne Window and Door Hardware

The range includes D Pull Handles, Levers for Hinged Doors, Lockbodies, Bifold Handles, Flush Pull Handles, Sash Handles and Escutcheons. All of the components are constructed from stainless steel (316) for a timeless, sophisticated appearance. The sleek profile has user comfort in mind – an important factor when you consider how often you open or close your windows and doors. Creativity and innovation are the driving factors behind our window and door hardware. The Lucerne range has been born out of that commitment, providing you with a fresh solution that will help you create the lifestyle you want.

Features:

- Consistent look
- Stainless steel (316)
- Locking sash fastener option

Aria Window and Door Hardware

Aria is our foundation furniture range with sleek styling designed to pair seamlessly with modern joinery.

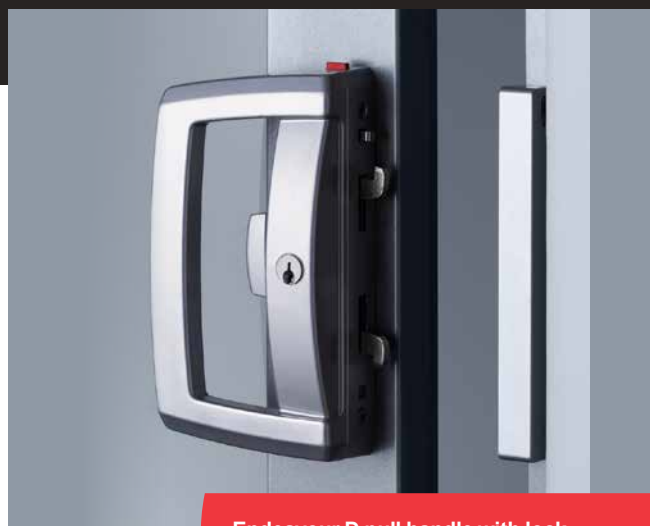

Endeavour D pull handle with lock



High profile window fastener with Helix Seal™

Aria Window and Door Hardware

Developed by ASSA ABLOY, Aria provides internal and external hardware solutions available in an array of colour finishes, simplifying the co-ordination of aesthetics throughout the home.

Aria Helix Fasteners are available with high and low-profile design options, as well as double tongue ventilation options and come with concealed fixings, while the Aria door hardware range covers hinged, sliding, bifold and French doors.

Speak to your local Rylock consultant for a full break down of Aria products and colour options.

Features:

- Consistent look
- Easy installation for new and retrofit applications
- Velocity™ Internal door option

Configurations

Windows and Doors

Use this page as a shopping list for selecting your home joinery needs

Windows

Awning windows



AW1 AW2 AW3 AW4

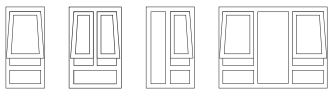

AW5 AW6 AW7 AW8

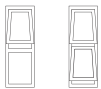

AW9 AW10

Casement and french windows



CW1 CW2 CW3 CW4



CW5 CW6 CW7 CW8

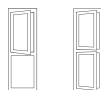

CW9 CW10

Sliding windows

Vertical



SW1

Horizontal



SW2 SW3

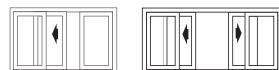

SW4 SW5



SW6

Speciality windows

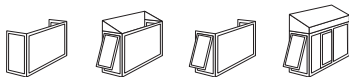

SPW1 SPW2 SPW3 SPW4

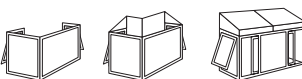

SPW5 SPW6 SPW7

Windows and Doors

Bifold windows and doors



BF(D/W)1 BF(D/W)2 BF(D/W)3



BF(D/W)4 BF(D/W)5 BF(D/W)6

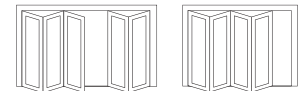

BF(D/W)7 BF(D/W)8

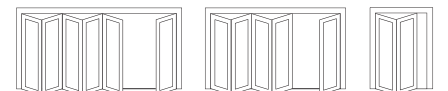

BF(D/W)9 BF(D/W)10 BF(D/W)11

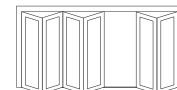

BF(D/W)12

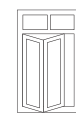

BF(D/W)13

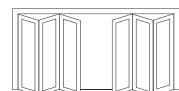

BF(D/W)14

*These are only a small section of the many possible configurations. Please talk to your local Rylock consultant to find the window and door configuration that best suits your lifestyle.



Doors

Foldback™ bifold doors



FBBFD1 FBBFD2 FBBFD3

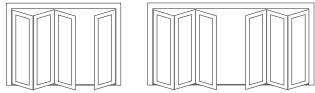

FBBFD4 FBBFD5

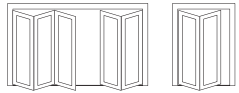

FBBFD6 FBBFD7

Hinged and entrance doors

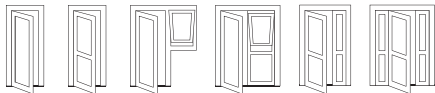

HD1 HD2 HD3 HD4 HD5 HD6



HD7 HD8 HD9 HD10 HD11

French doors

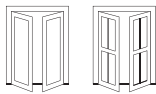

FD1 FD2



FD3 FD4 FD5

Ranchstacker™ doors

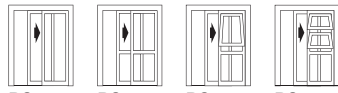

RS1 RS2 RS3 RS4



RS5 RS6 RS7 RS8



RS9 RS10 RS11



RS12

Ranchstacker™ sliding doors



RSS1 RSS2 RSS3

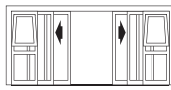

RSS4



RSS5 RSS6 RSS7

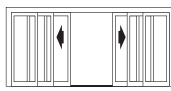

RSS8

Euroslider™ doors

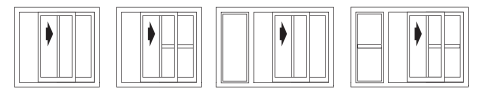

ES1 ES2 ES3 ES4



ES5 ES6 ES7



ES8 ES9



ES10 ES11 ES12



ES13

Eurostacker™ sliding doors

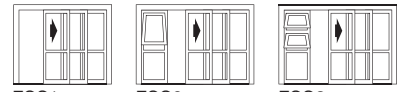

ESS1 ESS2 ESS3

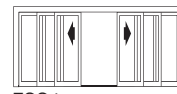

ESS4



ESS5 ESS6 ESS7

Active supporting members of:



Quality Assurance

Standards

Rylock Windows and Doors are tested in an Internationally Accredited New Zealand laboratory and comply with the New Zealand Standards NZS4211:2008 Specification for Performance of Windows and NZS3504:1979 Specification for Aluminium Windows. Rylock is a member of the Window and Glass Association of New Zealand.

Warranty

All Rylock Windows and Doors are backed by a minimum five year factory warranty.

Our Commitment to you

We will respond to your inquiry with constructive and practical advice.

- We will clearly explain our quotation, ensuring that you fully understand all aspects before moving forward
- We will keep you informed regarding the progress of any business you entrust to us
- We will ensure that your order is completed and delivered on time
- Our commitment will not end until we are sure you are satisfied with our work



Building Product Information Requirements

altus.co.nz/bpir



Download CAD files

Call now for a free quote



- 0800 RYLOCK
- 0800 795 625
- rylock.co.nz



Powered by

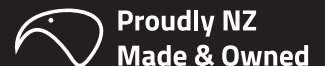

Your Local Rylock: